

KITCHEN & BEDROOM LIGHTING RANGE 2017

AT THE FOREFRONT OF LIGHTING INNOVATION



We pride ourselves on being different.

Our unique LED lighting collection is tailored specifically for the kitchen, bedroom and bathroom market. We place our focus on designing and developing our product range year-on-year to bring unique, design led products to market featuring the very latest in lighting innovation.

We continually aim to improve our product portfolio with new product designs and product upgrades. Our customer orientated focus is what sets us apart, your feedback really does guide the way we develop our product range.

Proud to be specialists in our field, our knowledge spans over 16 years so we're confident that we have the skills and understanding to provide our customers with the confidence to use our products to create the perfect finishing touch to every kitchen and bedroom design. We continually review our support structure and make any required improvements so you can be assured you are receiving the guidance you need.

To further emphasise the value we place on the high quality of our products we offer a 5 year guarantee on all kitchen and bedroom fittings in this brochure.

M. Linsky

MICHAEL LINSKY
DIRECTOR

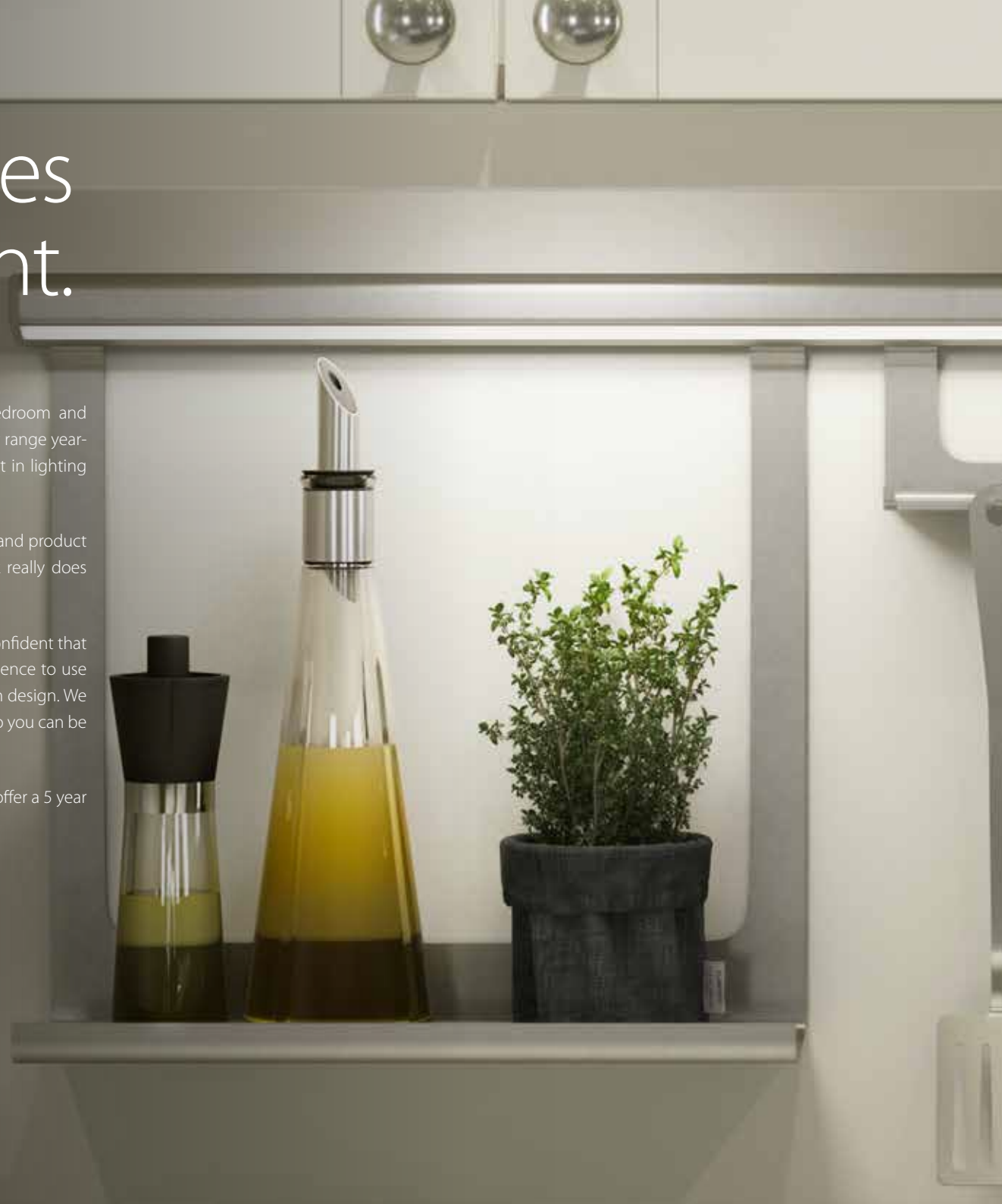



AWARD WINNING PRODUCT DESIGN



HOUSE BEAUTIFUL
BEST LIGHTING
SILVER AWARD
2016



INNOVATION AWARDS
EXCEL LONDON 2011





Contents

Why Sensio...

08	Quality
08	Design and innovation
08	Dedicated support
09	LED. The smart choice
09	Discover Sensio online
09	We make it easy to spec our lighting

Planning your lighting scheme...

10	Cool white vs. warm white
12	Designing a lighting scheme
13	Where to position lights in your kitchen
82	Sensio products for every bedroom
110	Cable connect system
111	Connecting by colour

Our product range...

14	Under Cabinet Spot Lighting	71	Fire Rated Ceiling Lighting
33	Under Cabinet Strip Lighting	72	Pendant Lighting
37	In Cabinet Lighting	74	Wireless Charging
39	Shelf Lighting	76	SensioPod
42	Drawer Lighting	86	Rechargeable Battery Wardrobe Lighting
45	Over Cabinet Lighting	94	Low Voltage Wardrobe Lighting
48	Plinth Lighting	98	LED Reading Lights
54	Flexible Strip Lighting	101	Lighting Control
63	Aluminium Profiles	112	Drivers
66	Sensio Midway Hanging Rail	113	Product Index

The importance of kitchen lighting...

Lighting is no longer just a kitchen accessory, it's a necessity. Transform your kitchen designs by incorporating a lighting scheme in the initial design stages. Just look at how a lighting scheme transforms this kitchen which only has ceiling spot lights.



Before **sensio** lighting

innovate.
create.
illuminate.™



After **sensio** lighting

Our values...



QUALITY IS PRIORITY

We pride ourselves on offering nothing other than products of the highest quality. We will only use the best components and materials to guarantee long-life performance, high light output and enhanced durability. To reflect the high quality of our product portfolio the products in this catalogue come complete with a 5 year guarantee for the peace of mind of both you and your customers. We are proud to have achieved ISO 9001: 2015 Quality Management Status, demonstrating our ability to meet both customer and applicable statutory and regulatory requirements.

DESIGN & INNOVATION

Design and development is at the heart of what we do. We take pride in the fact that we design and develop our innovative products in the UK, allowing us to put our expertise and industry knowledge to use, ensuring every detail is designed to meet the requirements of our customers. Our product portfolio is updated as frequently as is required to ensure we are always offering the latest in lighting innovation for our sector. We take into account the latest trends, latest LED technology and most importantly the feedback of our valued customers. We don't just introduce new products; we take popular existing designs and improve them to ensure we are always at the forefront of our industry.

DEDICATED SUPPORT

We offer comprehensive training and lighting advice so that you can get the most from your kitchen or bedroom lighting design. Our dedicated customer service team are here to help you with any needs or technical support you may have. Our comprehensive website and brochures are designed to help you with all your lighting requirements and make it easy to choose the right products for your customers. We take into account the questions we are asked and incorporate the answers into our marketing material. With over 16 years industry experience let us show you the Sensio way.

LED. THE SMART CHOICE

LED is fast becoming the only light to live by in the home. With other light sources becoming quickly obsolete, soon LED will be the only option. Although the initial cost of LED's are higher than less efficient light sources such as halogen and fluorescent, the cost of running them in the long term is significantly less. When comparing LED to halogen lamps you could save around £131 per year on energy bills. They also have a much longer lifespan, lasting up to 12 times longer than halogen fittings. An LED fitting will often outlive the kitchen it has been installed in. For more information on the benefits of investing in LED's visit www.sensio.co.uk

DISCOVER SENSIO ONLINE

The Sensio website has been designed to aid anyone who aspires to introduce a lighting scheme into their kitchen, bedroom or bathroom. On our website you can find information on all of our products including installation guides, technical information and frequently asked questions. Our customers can place orders online quickly and easily, check product availability, progress orders and manage their account. We are available on desktop, tablet and mobile to make it as convenient as possible. See for yourself by visiting www.sensio.co.uk

WE MAKE IT EASY TO SPEC OUR LIGHTING

We know exactly how important it is for you to show your customers how their kitchen design will look in the initial stages. Adding a stunning lighting scheme to your plans may just give you the edge and provide the additional 'wow' factor your customer is looking for. That's why we have made it as easy as possible for you by ensuring the entire Sensio portfolio is available on the leading kitchen design software; 2020, KBB Connect, KBB Smart and Compusoft.

Colour Temperatures

The LED colour that you choose for your kitchen can make a huge impact! Use these pages as a guide to help you choose the best LED colour for your kitchen design.



Warm White

Cool White



Beige Granite



Beige Matt

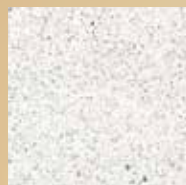

Sandstone



Marble

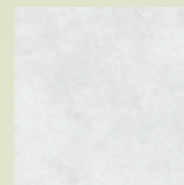

Grey Granite

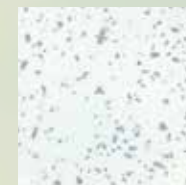

White Granite, Silver Fleck



White



Grey Matt



Oak Timbers



Oak Timbers



Walnut Timber

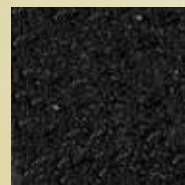

Black Granite, Gold Fleck

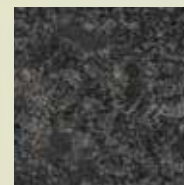

Dark Grey Granite



Slate

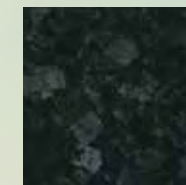

Gloss Slate



Black Granite, Silver Fleck

Warm white LED's emit a yellow glow (similar to that of halogen) and complement a traditional kitchen style featuring wood surfaces and muted worktops perfectly.

Cool white LED's are more suited to contemporary/modern kitchen styles. Gives a more modern effect, bouncing off gloss or contemporary surfaces to create a stunning effect.

The general rule of thumb is; for contemporary kitchen designs, opt for cool white LED and for traditional kitchen designs opt for warm white LED. However, it is important that you consider the worktop when selecting your under cabinet lighting. Use the guide above to ensure you choose the best LED colour for your designs every time.

What to consider when designing a lighting scheme...

1. Task Lighting

Understanding the lighting needs of a kitchen as a working space is crucial when planning a lighting scheme. Ask your customers how they envisage using the space and where they will need specific light sources. Task lighting does exactly what the name suggests, it is perfectly positioned to ensure the kitchen is an efficient working space for everyday tasks like food preparation. Typically, kitchen task lighting is positioned under wall units to illuminate the worktop, giving light exactly where it is needed. Reading lighting in the bedroom allows you to read your favourite book in bed without bright overhead lighting.



2. Mood Lighting

The key to achieving a lighting scheme that meets your customer's aesthetic aims as well as their practical needs is in understanding how they will use the space. Often the kitchen is used as a social space as well as a practical one, so the integration of mood lighting provides an additional depth to the room and a change in atmosphere when required. Consider lighting along the plinth, uplighting above wall units, lighting beneath breakfast bars or on the underside of a worktop and lighting the internal of glass fronted cabinets. Often the most overlooked aspect of a lighting scheme, mood lighting really does have the biggest impact.



3. Convenience Lighting

Convenience lighting illuminates cupboards, wardrobes and drawers when opened for ultimate ease of use. A beautiful extra which adds the ultimate finishing touch and brings a level of luxury to any kitchen or bedroom design.



Sensio products for every area of your kitchen...

- 14 Under Cabinet Spot Lighting
- 33 Under Cabinet Strip Lighting
- 37 In Cabinet Lighting
- 39 Shelf Lighting
- 42 Drawer Lighting
- 45 Over Cabinet Lighting
- 48 Plinth Lighting
- 54 Flexible Strip Lighting
- 63 Aluminium Profiles
- 66 Sensio Midway Hanging Rail
- 71 Fire Rated Ceiling Lighting
- 72 Pendant Lighting
- 74 Wireless Charging
- 76 Sensiopod
- 101 Lighting Control
- 112 Drivers



Look out for our latest products - marked by this symbol

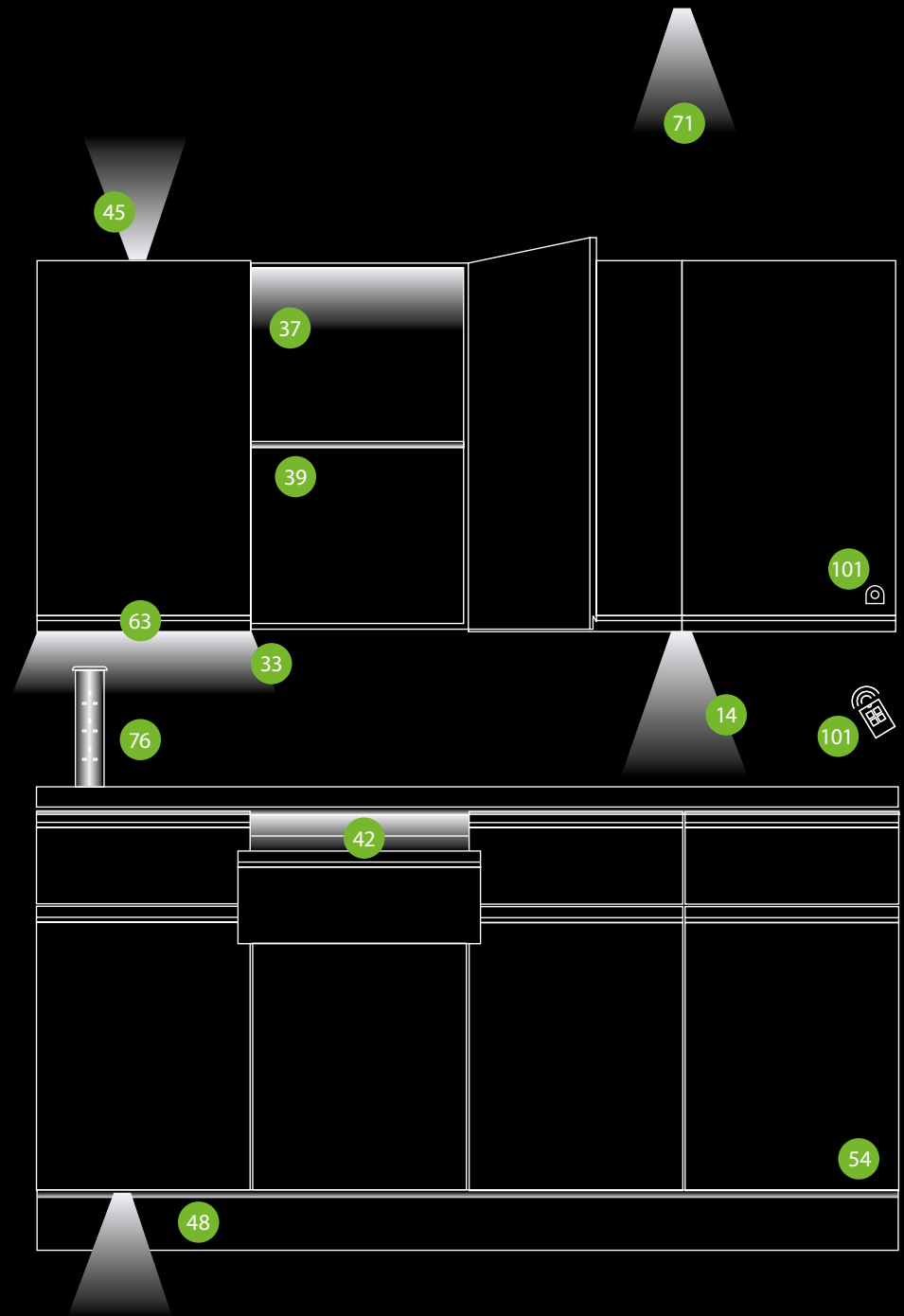

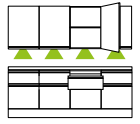

Under Cabinet Spot Lighting >



Under Cabinet Spot Lighting >

PAD2

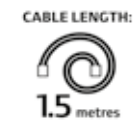
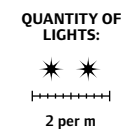
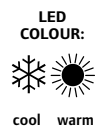

Prismatic LED Light



'improved, enhanced, upgraded'

- > An upgrade to the original LED PAD. This fitting features prismatic LED technology, one of the latest developments in LED technology for kitchen lighting. The fitting has an innovative diffuser with an etched design to completely diffuse the LED's.
- > This fitting has been redesigned with a depth of only 7mm. A discreet solution, great for kitchens without a pelmet.
- > The light panel has been significantly elongated to almost the full length of the fitting, allowing for an increased spread of light across the worktop. This fitting truly casts useable light exactly where you need it.
- > Absolutely no visible diodes reflect on the worktop to give the appearance of a sheet of pure light for a superior finish to your kitchen design.
- > PAD2 offers a superbly bright light output.
- > Available in both cool white and warm white LED, choose the option which will work best with the work surface and kitchen style.
- > This fitting has a maximum luminous efficacy of 88 lm/W.
- > Switch/dim using Sensio sensors and controllers.



Code	Wattage	LED Colour	Qty	Lumens	Driver	RRP
SE22006C0	3.5W	Cool White (5000K)	1	308 lm		£39.60
SE22006C2	7W	Cool White (5000K)	2	308 lm	15W included	£101.64
SE22006C3	10.5W	Cool White (5000K)	3	308 lm	15W included	£141.72
SE22006W0	3.5W	Warm White (3000K)	1	301 lm		£39.60
SE22006W2	7W	Warm White (3000K)	2	301 lm	15W included	£101.64
SE22006W3	10.5W	Warm White (3000K)	3	301 lm	15W included	£141.72

Accessories

Code	Description	RRP
SE9009	2.5m Extension Cable	£2.64

Cool White LED



Warm White LED

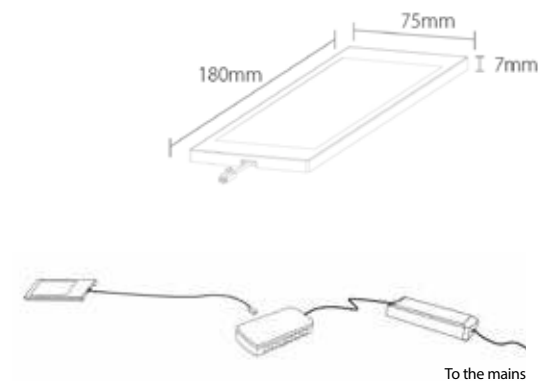

Alti

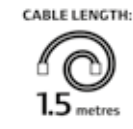
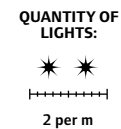

Square Prismatic LED Light



'the latest diffused LED technology'

- > The Alti features prismatic LED technology, one of the latest developments in LED technology for kitchen lighting. The fitting has an innovative diffuser with an etched design to completely diffuse the LED's.
- > This fitting has a depth of only 7mm. A discreet solution, great for kitchens without a pelmet.
- > The light panel is almost the full size of the fitting, allowing for an increased spread of light across the worktop. This fitting truly casts useable light exactly where you need it.
- > The Alti offers a superbly bright light output.
- > The silver surround gives this fitting a sleek and high quality finish.
- > Available in both cool white and warm white LED, choose the option which will work best with the work surface and kitchen style.
- > This fitting has a maximum luminous efficacy of 91 lm/W.
- > Switch/dim using Sensio sensors and controllers.



Code	Wattage	LED Colour	Qty	Lumens	Driver	RRP
SE21006C0	3.5W	Cool White (5000K)	1	319 lm		£21.12
SE21006C2	7W	Cool White (5000K)	2	319 lm	15W included	£62.04
SE21006C3	10.5W	Cool White (5000K)	3	319 lm	15W included	£83.52
SE21006W0	3.5W	Warm White (3000K)	1	291 lm		£21.12
SE21006W2	7W	Warm White (3000K)	2	291 lm	15W included	£62.04
SE21006W3	10.5W	Warm White (3000K)	3	291 lm	15W included	£83.52

Accessories

Code	Description	RRP
SE9009	2.5m Extension Cable	£2.64

Cool White LED



Warm White LED

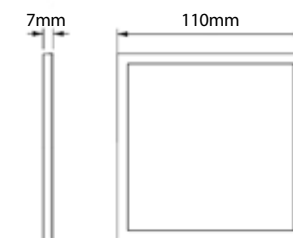

Venus

COB LED Recess/Surface Light

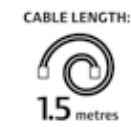
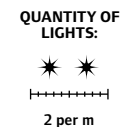

'COB LED - the latest LED technology'

- > Guaranteed to provide the highest luminous efficacy when compared to other like-for-like products currently on the market*
- > COB LED is a unique configuration of closely compacted LED's. It provides enhanced efficiency, a higher light output and a more uniform appearance.
- > The fitting is supplied with the collar. Can be either surface or recess mounted.
- > This fitting has a maximum luminous efficacy of 95 lm/W.
- > Stainless Steel fitting available with either cool white or warm white LED, great for both contemporary and traditional kitchens.
- > Despite the high output of this fitting, a low wattage of 3W is maintained.
- > IP43 rated - suitable for use close to a sink (protected against direct sprays or splashes of water).
- > Switch/dim using Sensio sensors and controllers.

* Correct at the time of print



Code	Wattage	LED Colour	Qty	Lumen's	Driver	RRP
SE21290C0	3W	Cool White (5000K)	1	285 lm	■	£22.81
SE21290C2	6W	Cool White (5000K)	2	285 lm	6W included	£62.50
SE21290C3	9W	Cool White (5000K)	3	285 lm	15W included	£96.24
SE21290W0	3W	Warm White (3000K)	1	270 lm	■	£22.81
SE21290W2	6W	Warm White (3000K)	2	270 lm	6W included	£62.50
SE21290W3	9W	Warm White (3000K)	3	270 lm	15W included	£96.24

Accessories		
Code	Description	RRP
SE9009	2.5m Extension Cable	£2.64

Surface Mounted



Recessed

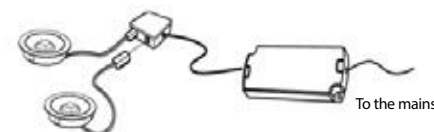
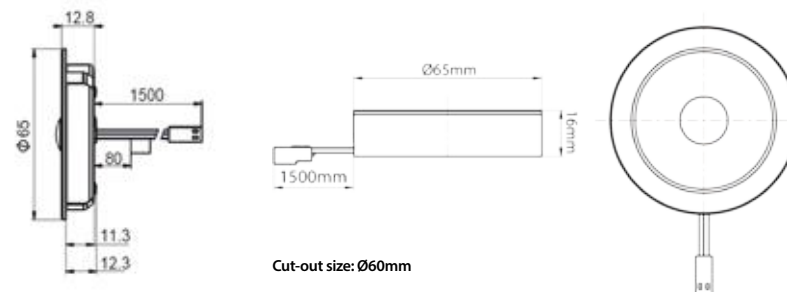

Under Cabinet Spot Lighting >

Titon COB LED Triangle Light

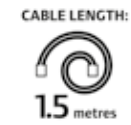
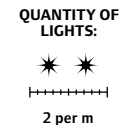
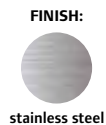

'COB LED in the ever popular triangle housing'

- > Guaranteed to provide the highest luminous efficacy when compared to other like-for-like products currently on the market*
- > COB LED is a unique configuration of closely compacted LED's. It provides enhanced efficiency, a higher light output and a more uniform appearance.
- > This fitting has a maximum luminous efficacy of 95 lm/W.
- > Stainless Steel fitting available with either cool white or warm white LED, great for both contemporary and traditional kitchens.
- > Despite the high output of this fitting, a low wattage of 3W is maintained.
- > IP43 rated - suitable for use close to a sink (protected against direct sprays or splashes of water).
- > Choose the triangle fitting to angle the light towards the front of the worktop.
- > Switch/dim using Sensio sensors and controllers.

* Correct at the time of print



Code	Wattage	LED Colour	Qty	Lumen's	Driver	RRP
SE21390C0	3W	Cool White (5000K)	1	285 lm		£25.08
SE21390C2	6W	Cool White (5000K)	2	285 lm	6W included	£68.76
SE21390C3	9W	Cool White (5000K)	3	285 lm	15W included	£99.48
SE21390W0	3W	Warm White (3000K)	1	270 lm		£25.08
SE21390W2	6W	Warm White (3000K)	2	270 lm	6W included	£68.76
SE21390W3	9W	Warm White (3000K)	3	270 lm	15W included	£99.48

Accessories

Code	Description	RRP
SE9009	2.5m Extension Cable	£2.64

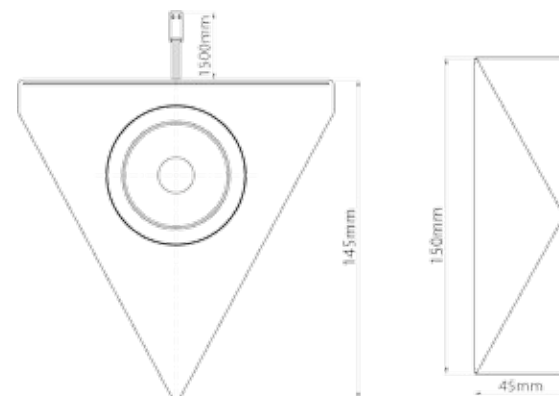

Under Cabinet Spot Lighting >

SensioSound LED Bluetooth Speaker Light

FINISH:



stainless steel

LED COLOUR:



cool warm

LAMP LIFE:



35,000
hours

DRIVER:



12V

RECOMMENDED LOCATION:



CABLE LENGTH:



1.8 metres

BEAM ANGLE:



120°

'kitchen lighting you can play your music through'

- > High output LED light with built-in Bluetooth RF audio speaker. Wirelessly connect your mobile device with the SensioSound to play your music through the product.
- > One device provides task lighting and allows you to play your music, perfect for when you're cooking or entertaining. Keep your kitchen surfaces tidy from external devices used to play music through.
- > Has the highest light output of any current Sensio under cabinet spot light.
- > Diffused LED points for a streamlined and aesthetically pleasing appearance.
- > Two of these fittings can be used in sync with one another to fill the room with music.
- > Quick and extremely simple to use, all you need is a SensioSound fitting, 12V driver and a mobile device with Bluetooth. No receivers, wireless boxes or additional wiring required.
- > Operational range of up to 10m.
- > Simple to install via surface mounted fixing with a steel effect finish.



Code	Wattage	LED Colour	Lumens	Driver	RRP
SE21090C0	8W	Cool White (5000K)	334 lm	■	£93.24
SE21090W0	8W	Warm White (3000K)	228 lm	■	£93.24

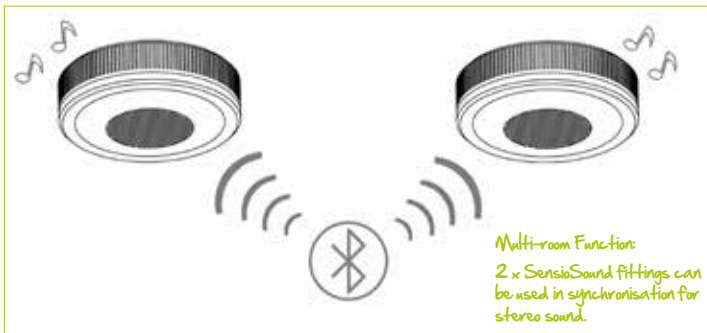

Search for 'SensioSound' via your Bluetooth device. Connect.



Once connected, select the music you'd like to play - whether it be music stored on your mobile device, music via the internet or radio.

Under Cabinet Spot Lighting >

SLS Quadra

LED Under Cabinet Light

FINISH:



aluminium

LED COLOUR:



cool warm

LAMP LIFE:



35,000 hours

DRIVER:



24V

QUANTITY OF LIGHTS:



2 per m

CABLE LENGTH:



2 metres

DIMMABLE:



BEAM ANGLE:



'multi-functional UK product design'

- > An upgrade from the original Quadra under and over cabinet lights. Designed by Sensio in the UK this is a unique product design.
- > Transform this product into an over cabinet light by purchasing the bracket.
- > The specialised lens on this product diffuses the LED's to create the appearance of invisible diodes.
- > Featuring a higher number of LED's than the original Quadra range for an improved light output.
- > The sensor has been upgraded to IR to maintain hygiene levels in the kitchen.
- > The fittings daisy chain together (run 6 from a 15W driver). Daisy chain non-sensor fittings into one sensor fitting for synchronised switching of all lighting in the run via the integrated IR sensor switch.
- > Specially designed mounting brackets for simple installation. The over cabinet bracket slides along the fitting for desired positioning of the light.
- > The new elongated design allows for an increased spread of light across the worktop.



Designed in the UK



Buy the bracket below to turn the under cabinet light into an over cabinet light

	Code	Wattage	LED Colour	Qty	Lumens	Driver	RRP
Non-sensor	SE21092C0	2.5W	Cool White (5600K)	1	170 lm	■	£19.56
	SE21092C2	5W	Cool White (5600K)	2	170 lm	6W included	£57.72
	SE21092C3	7.5W	Cool White (5600K)	3	170 lm	15W included	£83.04
	SE21092W0	2.5W	Warm White (3000K)	1	155 lm	■	£19.56
	SE21092W2	5W	Warm White (3000K)	2	155 lm	6W included	£57.72
	SE21092W3	7.5W	Warm White (3000K)	3	155 lm	15W included	£83.04
Sensor	SE21192C0	2.5W	Cool White (5600K)	1	170 lm	■	£24.48
	SE21192C2	5W	Cool White (5600K)	2	170 lm	6W included	£62.64
	SE21192C3	7.5W	Cool White (5600K)	3	170 lm	15W included	£87.84
	SE21192W0	2.5W	Warm White (3000K)	1	155 lm	■	£24.48
	SE21192W2	5W	Warm White (3000K)	2	155 lm	6W included	£62.64
	SE21192W3	7.5W	Warm White (3000K)	3	155 lm	15W included	£87.84

SLS
surface light source



The non-sensor fitting can also be used with the Sensio range of switches and controllers.



Buy the mounting bracket separately to transform the under cabinet light (without sensor) into an over cabinet light.

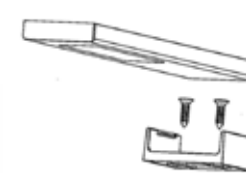

Over cabinet mounting (each bracket to be bought separately)

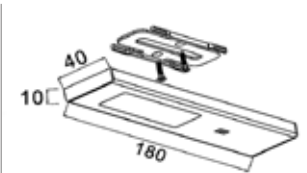

Under cabinet mounting (bracket provided with each fitting).

Optional accessories

Over Cabinet Mounting Bracket (SE240920) - £1.20
2.5m Extension Cable (SE9009) - £2.64

SE240920 - Mounting Bracket for Quadra SLS - £1.20

Under Cabinet Spot Lighting >

SLS Lara Surface/Recessed Light

FINISH:



aluminium

LED COLOUR:



cool warm

LAMP LIFE:



35,000 hours

DRIVER:



24V

QUANTITY OF LIGHTS:



2 per m

CABLE LENGTH:



1.5 metres

DIMMABLE:



BEAM ANGLE:



105°

'high quality, high output'

- > Surface Light Source (SLS) products are LED fittings with no visible LED points.
- > This fitting has a luminous efficacy of 72 lm/W, making it over 35% brighter than others on the market*.
- > The sleekest and brightest of all of the current Sensio SLS LED under cabinet spot lights.
- > Available in both cool white and warm white LED, choose the option which will work best with the work surface and kitchen style.
- > Use as task lighting under cabinets or to illuminate cabinet interiors in glass fronted wall units.
- > Spacer included, fitting can be surface mounted or recessed.
- > Long lamp life - lasts up to 32,500 hours more than halogen.
- > Switch from halogen and see significant savings on your energy bills.
- > Why this SLS spot light? The aluminium of this fitting has good thermal conduction, which in turn creates over double the light output than a steel SLS fitting.



Code	Wattage	LED Colour	Qty	Lumens	Driver	RRP
SE10166C0	3W	Cool White (5000K)	1	216 lm		£26.64
SE10166C2	6W	Cool White (5000K)	2	216 lm	6W included	£72.12
SE10166C3	9W	Cool White (5000K)	3	216 lm	15W included	£105.36
SE10166W0	3W	Warm White (3000K)	1	194 lm		£26.64
SE10166W2	6W	Warm White (3000K)	2	194 lm	6W included	£72.12
SE10166W3	9W	Warm White (3000K)	3	194 lm	15W included	£105.36

Accessories		
Code	Description	RRP
SE9009	2.5m Extension Cable	£2.64

Cool White LED



Warm White LED



Surface mounted



Recessed

Recessed



Cut-out size: Ø59-60mm

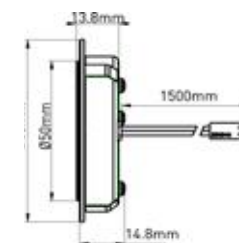

Surface mounted

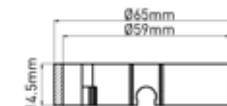

SLS
surface light source

Under Cabinet Spot Lighting >

SLS Hype LED Recess/Surface Light



FINISH:  stainless steel	LED COLOUR:  cool warm	LAMP LIFE:  50,000 hours	DRIVER:  24V	QUANTITY OF LIGHTS:  2 per m	CABLE LENGTH:  2.5 metres	DIMMABLE: 	BEAM ANGLE:  105°
--	---	---	--	--	---	---	---

'frosted cover for diffused LED's'

- > The fitting is supplied with the collar, can be either surface or recess mounted.
- > Sleek appearance. The LED's are diffused by a frosted cover making for a more aesthetically pleasing fitting, whilst retaining a high light output.
- > This fitting has a luminous efficacy of 61 lm/W, making it almost 10% brighter than others on the market*.
- > Stainless Steel fitting available with either cool white or warm white LED, great for both contemporary and traditional kitchens.
- > The style of the fitting makes it a direct replacement for a halogen under cabinet recess/surface light. Purchase in warm white LED for a very similar colour representation also.
- > Long lamp life - lasts up to 47,500 hours more than halogen.
- > Over 90% less energy used when comparing to halogen. Save money on electricity bills when switching from halogen.



* Correct at the time of print

Code	Wattage	LED Colour	Qty	Lumens	Driver	RRP
SE21100C0	1.65W	Cool White (5000K)	1	100 lm		£17.76
SE21100C2	3.3W	Cool White (5000K)	2	100 lm	6W included	£54.12
SE21100C3	4.95W	Cool White (5000K)	3	100 lm	6W included	£71.88
SE21100W0	1.65W	Warm White (3000K)	1	93 lm		£17.76
SE21100W2	3.3W	Warm White (3000K)	2	93 lm	6W included	£54.12
SE21100W3	4.95W	Warm White (3000K)	3	93 lm	6W included	£71.88

Accessories

Code	Description	RRP
SE9009	2.5m Extension Cable	£2.64

Surface Mounted



Recessed



Complete with the Sensio cable connect system

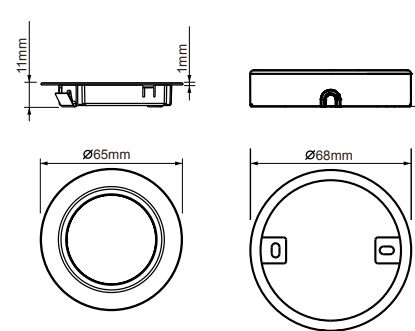

Cut-out size: Ø60mm

SLS
surface light source

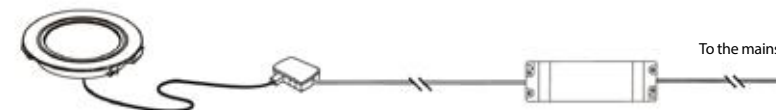

To the mains

Under Cabinet Spot Lighting >

SLS Bermuda LED Triangle Light

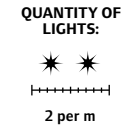

'the popular Bermuda with diffused LED's'

- > The LED's are diffused by a frosted cover making for a more aesthetically pleasing fitting, whilst retaining a high light output.
- > This fitting has a luminous efficacy of 61 lm/W, higher than other like-for-like products currently on the market*.
- > Stainless Steel fitting available with either cool white or warm white LED, great for both contemporary and traditional kitchens.
- > The style of the fitting makes it a direct replacement for a halogen under cabinet triangle light. Purchase in warm white LED for a very similar colour representation also.
- > Long lamp life - lasts up to 47,500 hours more than halogen.
- > Over 90% less energy used when comparing to halogen. Save money on electricity bills when switching from halogen.
- > Switch/dim using Sensio sensors and controllers.

* Correct at the time of print



Code	Wattage	LED Colour	Qty	Lumens	Driver	RRP
SE21000C0	1.65W	Cool White (5000K)	1	100 lm	■	£20.40
SE21000C2	3.3W	Cool White (5000K)	2	100 lm	6W included	£59.40
SE21000C3	4.95W	Cool White (5000K)	3	100 lm	6W included	£79.80
SE21000W0	1.65W	Warm White (3000K)	1	93 lm	■	£20.40
SE21000W2	3.3W	Warm White (3000K)	2	93 lm	6W included	£59.40
SE21000W3	4.95W	Warm White (3000K)	3	93 lm	6W included	£79.80

Accessories		
Code	Description	RRP
SE9009	2.5m Extension Cable	£2.64

Diffused LED's



SLS
surface light source

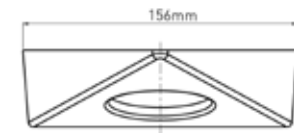
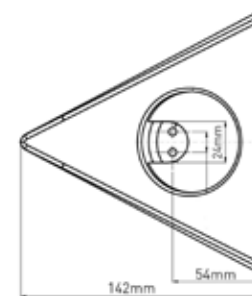

Complete with the Sensio cable connect system

Nico

240V LED Surface/Recessed Light

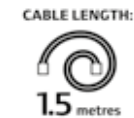
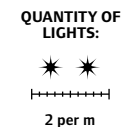

'anyone can install - our first 240V SLS fitting'

- > Surface Light Source (SLS) products are LED fittings with no visible LED points.
- > This fitting runs at 240V so no driver is required.
- > Extremely simple to install if you use the 6 way distribution block. Simply connect up to 6 of the Nico fittings into the ports on the distributor block and connect this directly to the mains supply (13A plug pre-wired to the SE211570).
- > The 2 and 3 light packs include the 6 way distribution block (SE211570).
- > When using the distribution block anyone can install these fittings - no need for Part P as it is all plug and play.
- > Use as task lighting under cabinets or to illuminate cabinet interiors in glass fronted wall units.
- > Spacer included, fitting can be surface mounted or recessed.
- > Extremely long lamp life. This fitting will more than likely outlive your kitchen.
- > A much smaller and neater fitting than GX53 with a connector small enough to fit through an 8mm hole.



Code	Wattage	LED Colour	Qty	Lumens	Voltage	RRP
SE21190C0	3W	Cool White (5000K)	1	180 lm	240V	£30.12
SE21190C2	6W	Cool White (5000K)	2	180 lm	240V	£76.20
SE21190C3	9W	Cool White (5000K)	3	180 lm	240V	£106.32
SE21190W0	3W	Warm White (3000K)	1	170 lm	240V	£30.12
SE21190W2	6W	Warm White (3000K)	2	170 lm	240V	£76.20
SE21190W3	9W	Warm White (3000K)	3	170 lm	240V	£106.32

Accessories		
Code	Description	RRP
SE211570	Nico 6 Way Distribution Block	£15.36
SE211750	Nico 1.5m Extension Cable	£5.64

SLS
surface light source



Cut-out: Ø 59-61mm



SE211750 - Nico
1.5m Extension
Cable



SE211570 - Nico 6
Way Distribution
Block

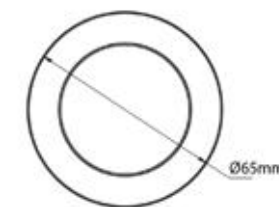

Subject to technical changes

Orbit Tiltable LED Light

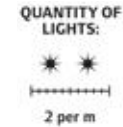

'tiltable, super bright LED spot light'

- > The tiltable centre section of this fitting allows you to direct the light to the position on the worktop or in a cabinet as you require.
- > The fitting is supplied with the collar, can be either surface or recess mounted.
- > 35% - 59% brighter than the SE9005HDWW/CW.
- > This fitting has a luminous efficacy of 59/81 lm/W.
- > High performance LED chips for optimum light output.
- > Available in both cool white and warm white LED to suit a variety of kitchen designs.
- > Use as task lighting under cabinets or to illuminate cabinet interiors.
- > Long lamp life - lasts up to 47,500 hours more than halogen.
- > Can be used with the range of Sensio switches and dimmers.
- > Die cast metal exterior with an aluminium effect finish.



Code	Wattage	LED Colour	Qty	Lumens	Driver	RRP
SE9008HDCW	3W	Cool White (5000K)	1	243 lm	■	£30.96
SE9008HDCWK2	6W	Cool White (5000K)	2	243 lm	6W included	£78.84
SE9008HDCWK3	9W	Cool White (5000K)	3	243 lm	15W included	£116.04
SE9008HDWW	3W	Warm White (3000K)	1	176 lm	■	£30.96
SE9008HDWWK2	6W	Warm White (3000K)	2	176 lm	6W included	£78.84
SE9008HDWWK3	9W	Warm White (3000K)	3	176 lm	15W included	£116.04

Accessories		
Code	Description	RRP
SE9009	2.5m Extension Cable	£2.64

Surface Mounted

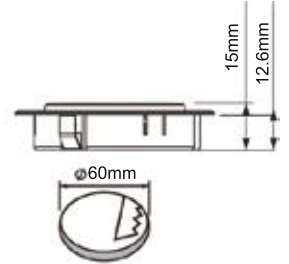

Recessed

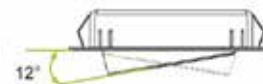

Cut-out size: Ø60mm

Under Cabinet Spot Lighting >

Novus HD LED Triangle Light

FINISH:
aluminium

LED COLOUR:
cool warm

LAMP LIFE:
50,000
hours

DRIVER:
24V

QUANTITY OF LIGHTS:
2 per m

CABLE LENGTH:
2.5 metres

DIMMABLE:

BEAM ANGLE:
50°

'slim exterior, high brightness'

- > Slim profile design. Perfect for contemporary kitchens without a pelmet.
- > A great option for those who prefer the classic triangular housing but are looking for a more slim, discreet fitting.
- > This fitting has a luminous efficacy of 80 lm/W, making it almost 30% brighter than equivalent products on the market*.
- > High definition LED, each diode has a lens over it to intensify the light output.
- > Available in both cool white and warm white LED, choose the option which will work best with the work surface and kitchen style.
- > Long lamp life - lasts up to 47,500 hours more than halogen.
- > 24 integrated LED's.
- > Compatible with Sensio sensors and controllers.

* Correct at the time of print



Code	Wattage	LED Colour	Qty	Lumens	Driver	RRP
SE9001HDCW	1.65W	Cool White (5000K)	1	132 lm	■	£23.44
SE9001HDCWK2	3.3W	Cool White (5000K)	2	132 lm	6W included	£72.00
SE9001HDCWK3	4.95W	Cool White (5000K)	3	132 lm	6W included	£103.44
SE9001HDWW	1.65W	Warm White (3000K)	1	123 lm	■	£26.40
SE9001HDWWK2	3.3W	Warm White (3000K)	2	123 lm	6W included	£77.04
SE9001HDWWK3	4.95W	Warm White (3000K)	3	123 lm	6W included	£103.44

Accessories

Code	Description	RRP
SE9009	2.5m Extension Cable	£2.64

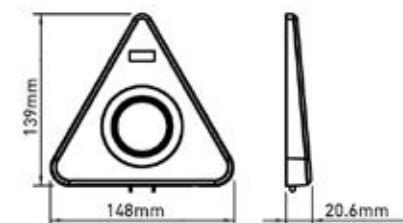

Complete with the Sensio cable connect system

Under Cabinet Spot Lighting >

Hype HD LED Surface Light

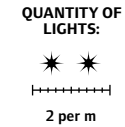

'the classic high output LED surface/recess light'

- > The fitting is supplied with the collar, can be either surface or recess mounted.
- > Stainless steel fitting available with either cool white or warm white LED, great for both contemporary and traditional kitchens.
- > This fitting has a luminous efficacy of 80 lm/W, making it almost 30% brighter than equivalent products on the market*.
- > High definition LED – a lens over each diode intensifies the light output.
- > Use as task lighting under cabinets or to illuminate cabinet interiors in glass fronted wall units.
- > Over 90% less energy used when comparing to halogen. Save money on electricity bills when switching from halogen to HD LED.
- > Long lamp life - lasts up to 32,500 hours more than halogen.
- > Fittings are complete with the Sensio cable connect system.
- > Can be used with the range of Sensio switches and dimmers.



Code	Wattage	LED Colour	Qty	Lumens	Driver	RRP
SE9005HDSSCW	1.65W	Cool White (5000K)	1	132 lm		£17.76
SE9005HDSSCWK2	3.3W	Cool White (5000K)	2	132 lm	6W included	£54.12
SE9005HDSSCWK3	4.95W	Cool White (5000K)	3	132 lm	6W included	£71.88
SE9005HDSSWW	1.65W	Warm White (3000K)	1	123 lm		£17.76
SE9005HDSSWWK2	3.3W	Warm White (3000K)	2	123 lm	6W included	£54.12
SE9005HDSSWWK3	4.95W	Warm White (3000K)	3	123 lm	6W included	£71.88

Accessories

Code	Description	RRP
SE9009	2.5m Extension Cable	£2.64



Surface Mounted



Recessed

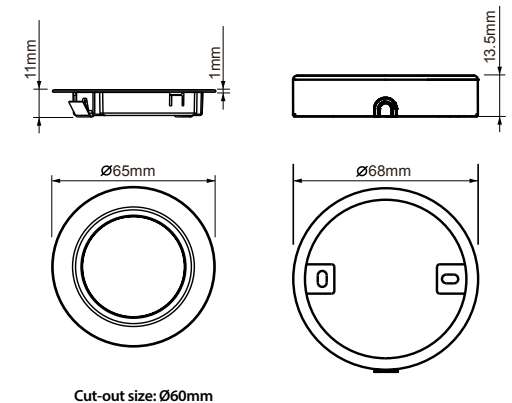
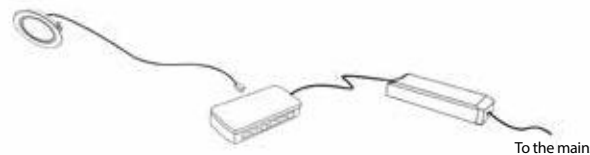

Bermuda HD LED Triangle Light

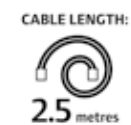
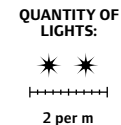

'traditional look, modern solution'

- > Stainless Steel fitting available with either cool white or warm white LED, great for both contemporary and traditional kitchens.
- > High Definition LED, each diode has a lens over it to intensify the light output.
- > This fitting has a luminous efficacy of 80 lm/W, making it almost 30% brighter than equivalent products on the market*.
- > The style of the fitting makes it a direct replacement for a halogen under cabinet triangle light. Purchase in warm white LED for a very similar colour representation also.
- > Long lamp life - lasts up to 32,500 hours more than halogen.
- > Over 90% less energy used when comparing to halogen. Save money on electricity bills when switching from halogen to HD LED.
- > Compatible with Sensio sensors and controllers.



Code	Wattage	LED Colour	Qty	Lumens	Driver	RRP
SE9001HDSSCW	1.65W	Cool White (5000K)	1	132 lm	■	£20.40
SE9001HDSSCWK2	3.3W	Cool White (5000K)	2	132 lm	6W included	£59.40
SE9001HDSSCWK3	4.95W	Cool White (5000K)	3	132 lm	6W included	£79.80
SE9001HDSSWW	1.65W	Warm White (3000K)	1	123 lm	■	£20.40
SE9001HDSSWWK2	3.3W	Warm White (3000K)	2	123 lm	6W included	£59.40
SE9001HDSSWWK3	4.95W	Warm White (3000K)	3	123 lm	6W included	£79.80

Accessories

Code	Description	RRP
SE9009	2.5m Extension Cable	£2.64

Cool White LED



Warm White LED

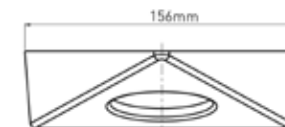
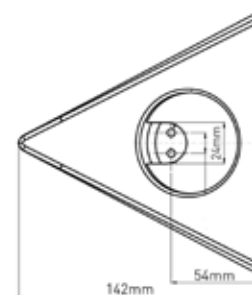

Complete with the Sensio cable connect system

Under Cabinet Spot Lighting >

Ora

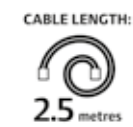
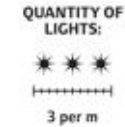

LED Square Surface Light



'perfect for the minimalist kitchen design'

- > Stainless Steel fitting available with either cool white or warm white LED - great for both contemporary and traditional kitchens.
- > This fitting has a depth of only 8.8mm, making it perfect where invisible lighting is required.
- > Now 72% brighter than when the product was originally launched.
- > This fitting has a luminous efficacy of 75 lm/W, making it over 20% brighter than equivalent products on the market*.
- > Use as task lighting under cabinets or to illuminate cabinet interiors in glass fronted wall units.
- > 18 High Definition LED's integrated, each diode has a lens over it to intensify the light output.
- > Long lamp life of 35,000 hours.
- > Can be used with the range of Sensio switches and dimmers.



Code	Wattage	LED Colour	Qty	Lumens	Driver	RRP
SE9007HDCW	1.8W	Cool White (5000K)	1	135 lm		£20.52
SE9007HDCWK2	3.6W	Cool White (5000K)	2	135 lm	6W included	£57.84
SE9007HDCWK3	5.4W	Cool White (5000K)	3	135 lm	6W included	£78.36
SE9007HDWW	1.8W	Warm White (3000K)	1	128 lm		£20.52
SE9007HDWWK2	3.6W	Warm White (3000K)	2	128 lm	6W included	£57.84
SE9007HDWWK3	5.4W	Warm White (3000K)	3	128 lm	6W included	£78.36

Accessories

Code	Description	RRP
SE9009	2.5m Extension Cable	£2.64

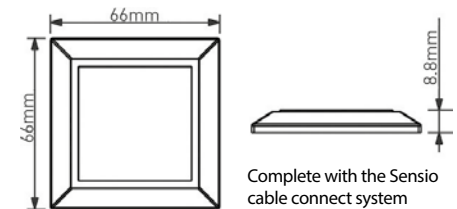

Under Cabinet Spot Lighting >

Calida LED Flat Disc Light

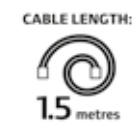

'stylish, super thin,
compact design'

- > This fitting can be used under kitchen cabinets as a task light or inside glass fronted wall units to introduce stunning, yet discreet mood lighting.
- > The wide beam angle of the LED's in this fittings gives a superb spread of light.
- > This fitting is extremely discreet, having a depth of only 6mm.
- > Extremely low wattage. Each fitting runs at only 1.4W.
- > Available in both cool white and warm white LED. This fitting looks stunning in both contemporary and traditional kitchens alike.
- > 19 LED's integrated.
- > Surface mount using two screws (provided with each fitting).



Code	Wattage	LED Colour	Qty	Lumens	Driver	RRP
SE10138CW	1.4W	Cool White (5000K)	1	75 lm		£15.24
SE10138CWK3	4.2W	Cool White (5000K)	3	75 lm	6W included	£60.48
SE10138WW	1.4W	Warm White (3000K)	1	73 lm		£15.24
SE10138WWK3	4.2W	Warm White (3000K)	3	73 lm	6W included	£60.48

Accessories

Code	Description	RRP
SE9009	2.5m Extension Cable	£2.64

Cool white LED



Warm white LED

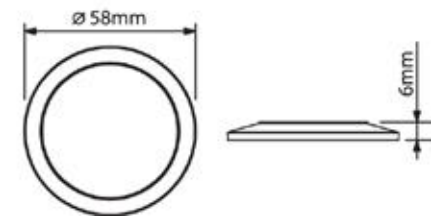

Under Cabinet Spot Lighting >

GX53 Circa LED Recessed/Surface Light

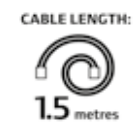
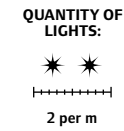

'mains LED spot lighting - anyone can install'

- > The steel fitting can be either surface mounted or recessed.
- > Buy the fitting and then choose your LED lamp from the table below.
- > Choose from two high power, energy efficient GX53 LED lamps, available in both cool white or warm white LED.
- > This fitting runs at 240V so no driver is required. Connect directly to the mains.
- > Extremely simple connection system, the mains cable has a connector attached which plugs into the SE11175 (see accessories below). When this accessory is used these fittings can be installed by anyone as the distribution unit has a 13A plug pre-wired.
- > 50 diodes integrated in the GX53 lamps for optimum light output.
- > The lamps are simple to replace via a simple twist and lock mechanism.



1 Choose your GX53 fitting

Code	Finish	Fitting Type	Connection	RRP
SE11146SS	Stainless Steel	Recess/Surface	240V	£14.04

2 Choose your GX53 lamp

Code	Wattage	LED Colour	LED Qty	Lumens	Connection	RRP
SE10156CW	3W	Cool White (5800K)	50	250 lm	240V	£21.12
SE10156WW	3W	Warm White (3000K)	50	245 lm	240V	£24.96

3 Do you require GX53 accessories?

SE11172	GX53 2m Extension Cable	£3.84
SE11175	GX53 6 Way Distributor Block with 1.5m Cable & Plug	£12.48

1



2

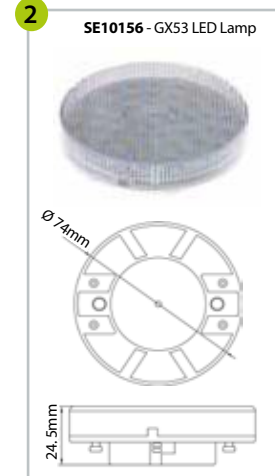

3



Under Cabinet Spot Lighting >

GX53 Trigon LED Triangle Light

FINISH:



stainless steel

LED COLOUR:



cool warm

LAMP LIFE:



35,000
hours



240V

QUANTITY OF LIGHTS:

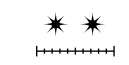

2 per m

CABLE LENGTH:



1.5 metres

BEAM ANGLE:



120°

'no LED driver required'

- > Stainless steel triangle light fitting only.
- > Buy the fitting and then choose your LED lamp from the table below.
- > This fitting runs at 240V so no driver is required. Connect directly to the mains.
- > Choose from cool white or warm white high power, energy efficient GX53 LED lamps.
- > Extremely simple connection system, the mains cable has a connector attached which plugs into the SE11175 (see accessories below). When this accessory is used these fittings can be installed by anyone.
- > 50 diodes integrated for optimum light output.
- > The angled aspect of a triangle light fitting means the light is directed forward onto the worktop.
- > The lamps are simple to replace via a simple twist and lock mechanism.



1 Order your GX53 triangle light fitting

Code	Finish	Connection	RRP
SE11147SS	Stainless Steel	240V	£12.72

2 Choose your GX53 lamp

Code	Wattage	LED Colour	LED Qty	Lumens	Connection	RRP
SE10156CW	3W	Cool White (5800K)	50	250 lm	240V	£21.12
SE10156WW	3W	Warm White (3000K)	50	245 lm	240V	£24.96

3 Do you require GX53 accessories?

SE11172	GX53 2m Extension Cable	£3.84
SE11175	GX53 6 Way Distributor Block with 1.5m Cable & Plug	£12.48

1

SE11147SS with SE10156CW lamp

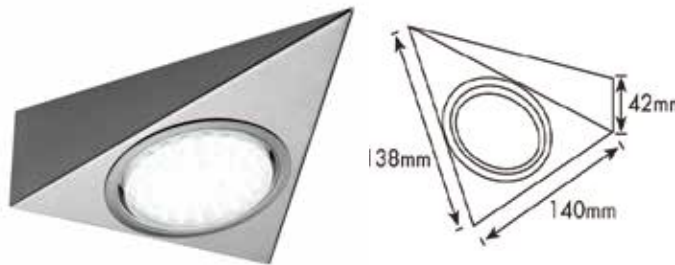

2

SE10156 - GX53 LED Lamp

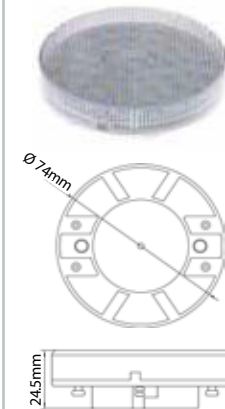

3

SE11172 - GX53 2m extension cable



SE11175 - 6 way distribution block with plug



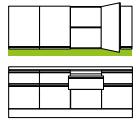

Under Cabinet Strip Lighting >



Arrow

Slim Profile SLS LED Strip Light



'continuous, diffused LED under cabinet lighting'

- > The Arrow contains a unique configuration of diffusers that evenly distribute the light, meaning there are absolutely no visible LED points.
- > This slimline fitting is extremely adaptable. We offer 4 lengths, however the strips can be seamlessly interlinked with no visible joins for a superior streamline appearance.
- > With a slim profile of only 13mm this fitting is extremely discreet.
- > Available in both cool and warm white LED, the Arrow is suitable for both contemporary and more traditional kitchen designs also.
- > A high lumen output and wide beam angle for an optimum light cast.
- > When interlinking the Arrow a maximum length of 3600mm can be achieved.
- > Each end cap measures 20mm - ensure you account for this when specifying.
- > The starter cable is to be purchased separately. One starter cable is required for each run of strips to be connected back to the driver.



Code	Wattage	Length	LED Colour	Lumens	Driver	RRP
SE9071HDCW	2.5W	200mm	Cool White (5000K)	295 lm		£21.78
SE9071HDWW	2.5W	200mm	Warm White (3000K)	258 lm		£21.78
SE9074HDCW	4W	300mm	Cool White (5000K)	472 lm		£28.44
SE9074HDWW	4W	300mm	Warm White (3000K)	413 lm		£28.44
SE9075HDCW	7.5W	570mm	Cool White (5000K)	958 lm		£54.36
SE9075HDWW	7.5W	570mm	Warm White (3000K)	838 lm		£54.36
SE9076HDCW	11.5W	870mm	Cool White (5000K)	1387 lm		£84.96
SE9076HDWW	11.5W	870mm	Warm White (3000K)	1213 lm		£84.96

Simple 'click' interlinking system



Simple to install via clips provided



No break in the light when 2 Arrows are connected

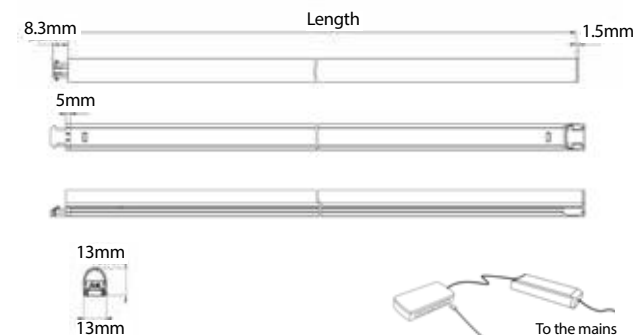
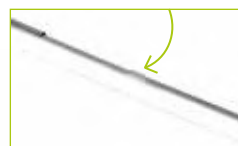

Cable & Connectors

1.5m Arrow Starter Cable - (SE9078HD) - £4.56
 Required to run the Arrow (at least one required per run)

50mm Arrow Corner Connector - (SE9077HD) - £3.00
 500mm Inter-Connecting Cable - (SE9079HD) - £3.48



SE9078HD



SE9077HD



SE9079HD

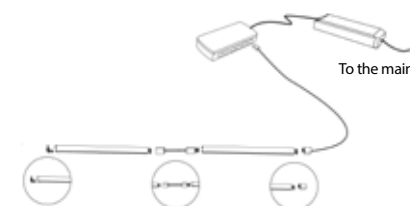

Subject to technical changes



Under Cabinet Strip Lighting >

Connex 240V SLS LED Strip Light

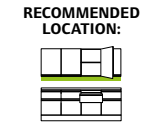

'the LED alternative to T5 with no visible LEDs'

- > The Connex features SLS (surface light source) technology meaning the LED points are not seen. The diffused look of the LED's produces the same look as a T5 fluorescent with an even higher light output.
- > Mains fitting for ultra simple installation.
- > Available in warm white LED, the perfect LED strip light for the more traditional kitchen design.
- > Save on energy bills. These LED options run at a much lower wattage than the fluorescent equivalents.
- > The fittings can be directly interlinked to form a continuous run of light.
- > Each fitting is supplied with 1m of mains cable for simple installation (no driver required).



Code	Wattage	Length	Lumens	Kelvin	Connection	RRP
SE10173W0	4.4W	270mm	450 lm	3000K	240V	£25.32
SE10183W0	6.4W	396mm	540 lm	3000K	240V	£27.24
SE10193W0	8.4W	524mm	720 lm	3000K	240V	£32.52
SE10203W0	10.2W	623mm	900 lm	3000K	240V	£35.28

Accessories

Code	Description	Cable Length	RRP
SE120450	Connex Inter-Connecting Lead	500mm	£3.12
SE120750	Connex Inter-Connecting Lead	1.5m	£4.20

Use these cables between two Connex fittings when direct connection is not possible. This allows you to run a single mains cable for one run of lights.

SLS
surface light source

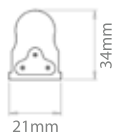
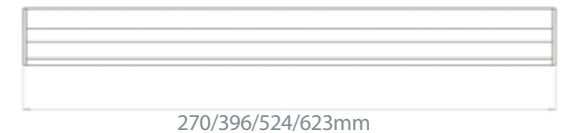

Under Cabinet Strip Lighting >

Albus LED Strip Light

FINISH:



LED COLOUR:



LAMP LIFE:



RECOMMENDED LOCATION:



CABLE LENGTH:



BEAM ANGLE:



'ultimate ease of installation'

- > The fittings can be directly interlinked to form a continuous run of light.
- > Mains LED fitting, no external driver required.
- > Integrated on/off switch on each fitting. Switch via one fitting when in a run.
- > Each fitting contains a high number of LED's for optimum light output.
- > Angled fitting for optimum illumination of the kitchen worktop.
- > Available in cool white LED, this mains powered LED strip light has an extremely high light output to provide powerful task lighting.
- > Each fitting is supplied with a 1m length of mains cable for simple installation.



Code	Wattage	Length	LED Colour	Lumens	Connection	RRP
SE12250 - 250mm	2.7W	250mm	Cool White (6000K)	235 lm	240V	£38.40
SE12330 - 330mm	3.6W	330mm	Cool White (6000K)	325 lm	240V	£43.92
SE12550 - 550mm	6.8W	550mm	Cool White (6000K)	605 lm	240V	£63.00

Accessories

Code	Description	RRP
SE12001	Male & Female Connector	£4.68
SE12005	500mm Link Cable	£3.12



Accessories

SE12001

Allows you to wire a length of mains cable between 2 fittings to link them together.



SE12005

To link two units together where direct interlinking is not suitable.



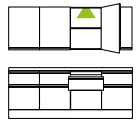

In Cabinet Lighting >



For retrofit in
cabinet lighting see
pages 88 - 93

SLS Quadra LED In Cabinet Light

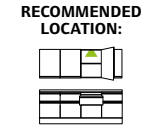

'improved design, unique to Sensio in the UK'

- > An upgrade from the original Quadra PLUS-I. Designed by Sensio in the UK this is a unique product design.
- > The specialised lens on this product diffuses the LED's to create the appearance of invisible diodes.
- > The integrated IR sensor operates the light as the cabinet door is opened/ closed. With light coloured doors the fitting can be placed 50mm from the door. With dark coloured doors the distance is 25mm.
- > Featuring a higher number of LED's than the original Quadra range for an improved light output.
- > Specially designed mounting bracket for simple installation.
- > The new elongated design allows for an increased spread of light throughout the cabinet.



Designed in the UK

Cabinet used is for illustrative purposes only

Code	Wattage	LED Colour	Lumens	Driver	RRP
SE23092C0	2.5W	Cool White (5600K)	170 lm	■	£28.56
SE23092W0	2.5W	Warm White (3000K)	155 lm	■	£28.56

Accessories		
Code	Description	RRP
SE9009	2.5m Extension Cable	£2.64

SLS
surface light source

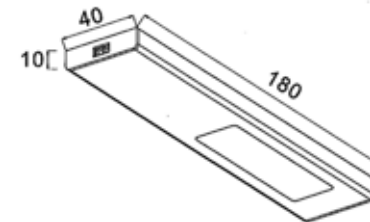

Measurements are in mm

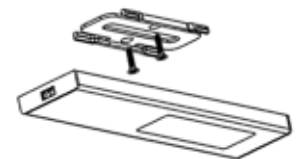

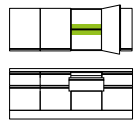

Shelf
Lighting >



Edge SLS LED Glass Clip Light



'glass shelves are a feature. Light them'

- > Fits a 6-8mm pane of glass.
- > Use on glass shelves inside glass fronted cabinets to introduce soft, ambient mood lighting.
- > The white diffused finish of the profile means the lights shines out towards the front edge of the glass and illuminates the inside of the cabinet itself also.
- > We listened to your customer feedback and have now introduced a warm white LED option for traditional style kitchens.
- > Can be cut to length if required (every 90mm or 7 LED's along the PCB).
- > The integrated diffuser creates the 'no dot' look on the front edge of the glass.
- > Extremely low wattage, meaning minimal energy consumption.
- > Use two lengths side by side for longer units.
- > Simple to install, clips onto the back of a glass pane and connects up to the suitable driver.
- > A relatively low cost item which creates a stunning effect.



Code	Wattage	LED Colour	Length	LED's	Lumens	Driver	RRP
SE9063HDCW	2W	Cool White (5000K)	450mm	35	281 lm		£18.36
SE9063HDWW	2W	Warm White (3000K)	450mm	35	220 lm		£18.36

Accessories		
Code	Description	RRP
SE9009	2.5m Extension Cable	£2.64

Cool white LED



Warm white LED



Measurements in mm

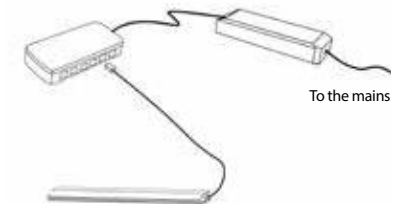
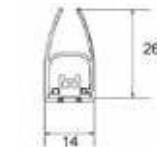

Inset shows the integrated diffuser on the Edge LED Glass Clip Light.

SLS
surface light source

Shelf Lighting >

Florence

IP44 LED Glass Shelf Light

FINISH:



aluminium

LED COLOUR:



cool

LAMP LIFE:



hours

RECOMMENDED LOCATION:



CABLE LENGTH:



1 metre

'add ambience and additional storage space'

- > The Florence has an aluminium frame containing a high power LED strip light. A pane of frosted glass slots into the frame and a diffused and subtle lighting effect is created.
- > High output, cool white LED strip integrated.
- > On/off switch integrated (located on the underside of the shelf – to the right hand side when fit).
- > LED driver built-in so no need to purchase and fit a separate driver.
- > Long lifespan of the LED strip integrated so there is no need for replacement lamps.
- > The maximum weight load of the shelf is 3kg.
- > IP44 rated, protected against splashing water. This fitting is perfect if you require additional storage space/illumination in close proximity to the sink. (The shelf must be fit a minimum of 0.6m away from the sink).



Code	Wattage	LED Colour	Length	Width	Connection	RRP
SE30156W0	12W	Cool White (4500K)	500mm	135mm	240V	£82.92

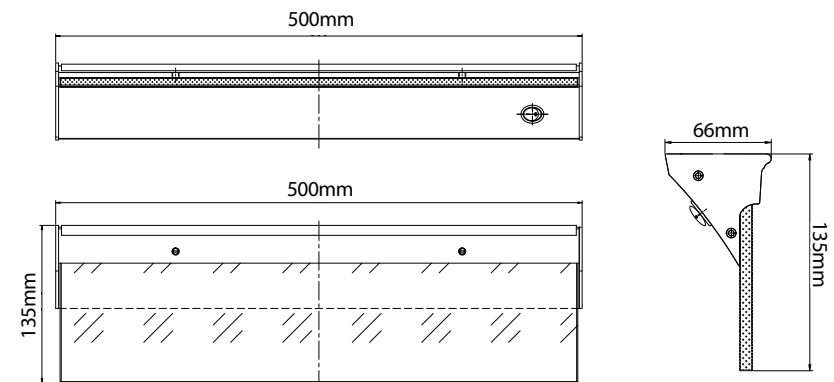
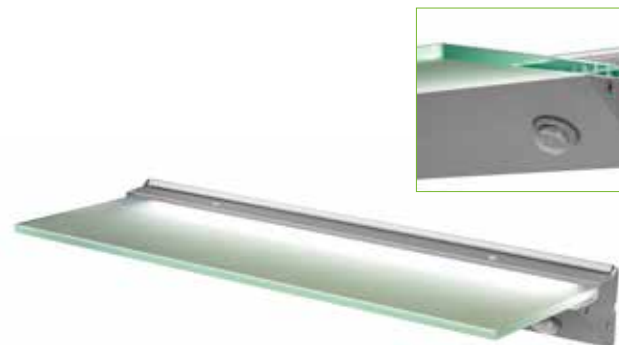

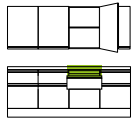

Drawer Lighting >



Drawer Lighting >

Verso LED Drawer Light

FINISH:
aluminium

LED COLOUR:
cool

LAMP LIFE:
30,000
hours

DRIVER:
12V

RECOMMENDED
LOCATION:

CABLE LENGTH:
2 metres

BEAM ANGLE:
120°

'the ultimate functional light'

- > Various lengths available to suit standard drawer carcasses.
- > Cool white high definition LED to provide optimum light output.
- > IR sensor integrated on the front edge of the fitting, as soon as the drawer is opened the light will illuminate. Once the drawer is closed the fitting will switch off immediately to ensure no energy wastage.
- > The ideal solution to illuminate pan drawers.
- > Low wattage, meaning a full drawer stack can be illuminated using only one LED driver.
- > Brackets and cable tidy supplied.
- > This fitting is suitable for use in both the kitchen and the bedroom.



Code	Wattage	LED Colour	Length	LEDs	Lumens	Driver	RRP
SE7300HDCW	2.6W	Cool White (4500K)	462mm	33	205 lm		£42.97
SE7305HDCW	3.3W	Cool White (4500K)	562mm	42	250 lm		£50.40
SE7310HDCW	4.5W	Cool White (4500K)	762mm	60	340 lm		£57.60
SE7315HDCW	5.4W	Cool White (4500K)	862mm	72	380 lm		£64.68
SE7320HDCW	6W	Cool White (4500K)	962mm	81	430 lm		£74.04
SE7325HDCW	7.3W	Cool White (4500K)	1162mm	99	515 lm		£81.36

Accessories		
Code	Description	RRP
SE9009	2.5m Extension Cable	£2.64

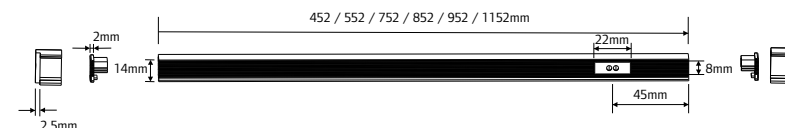

Vista LED Battery Drawer Light

FINISH:
aluminium

LED COLOUR:
cool

LAMP LIFE:
35,000
hours

BATTERY OPERATED:

RECOMMENDED LOCATION:

BEAM ANGLE:
70°

'no wiring - anyone can install'

- > No wiring necessary so anyone can install this fitting.
- > Requires 4 x AAA batteries to run (not included).
- > IR Sensor in-built (located in the centre of the fitting).
- > Two functions of this fitting:
 - Use as a drawer/in-cabinet light (the light switches on with the opening of a drawer/door).
 - Use as an under unit light (the light switches on/off when a hand passes the sensor).
- > When used for 3 minutes per day the batteries in the fitting will last approximately 1.5 years.
- > 5cm detection range of the IR Sensor.
- > The function-switch button is on the back of the fitting, press once to change the function of the product.



Code	Wattage	LED Colour	Cable	Power Source	RRP
SE9030HD	0.8W	Cool White (6500K)	n/a	4 x AAA Batteries	£29.16

*Ideal
Fit in the drawer where the
forks and batteries are kept in
case of a power cut.*



1. If mounted inside a drawer, select the monostable function.
2. Open the drawer, light turns on.
3. Close the drawer, light turns off.



1. If mounted underneath a cabinet, select the bistable function.
2. Move hand within 5cm of the IR sensor, light turns on.
3. Move hand within 5cm of the IR sensor once more, light turns off.

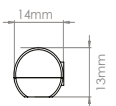
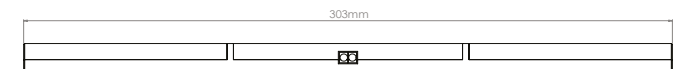

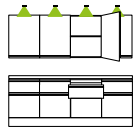

Over Cabinet Lighting >



Over Cabinet Lighting >

SLS Quadra

LED Under/Over Cabinet Light

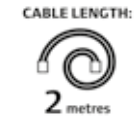
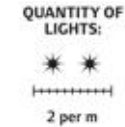



'multi-functional UK product design'

- > An upgrade from the original Quadra PLUS -O. Designed by Sensio in the UK this is a unique product design.
- > Use this product as an over cabinet light by purchasing the mounting bracket (SE240920).
- > The mounting brackets are specially designed for simple installation. The over cabinet bracket slides along the fitting for desired positioning of the light.
- > The specialised lens on this product diffuses the LED's to create the appearance of invisible diodes.
- > Featuring a higher number of LED's than the original Quadra range for an improved light output.
- > The fittings daisy chain together (run 6 from a 15W driver).
- > The new elongated design allows for an increased spread of light across the cabinet front.
- > This fitting is a great option for creating mood lighting by illuminating your kitchen cabinets or use above wardrobes for a simple way to introduce mood lighting in the bedroom.



Designed in the UK

Code	Wattage	LED Colour	Qty	Lumens	Driver	RRP
SE21092C0	2.5W	Cool White (5600K)	1	170 lm		£19.56
SE21092C2	5W	Cool White (5600K)	2	170 lm	6W included	£57.72
SE21092C3	7.5W	Cool White (5600K)	3	170 lm	15W included	£83.04
SE21092W0	2.5W	Warm White (3000K)	1	155 lm		£19.56
SE21092W2	5W	Warm White (3000K)	2	155 lm	6W included	£57.72
SE21092W3	7.5W	Warm White (3000K)	3	155 lm	15W included	£83.04

Accessories

Code	Description	RRP
SE240920	Mounting Bracket for Quadra SLS	£1.20
SE9009	2.5m Extension Cable	£2.64

SLS Quadra without Bracket



SLS Quadra with Bracket



SLS
surface light source

SE240920 - Mounting Bracket

(required to transform the SLS Quadra into an over cabinet light)

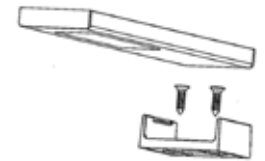

Over cabinet mounting

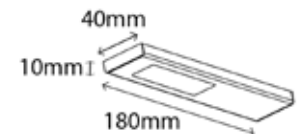

Packs include the Mounting Bracket (SE240920), one bracket for each light fitting in the pack.

For individual fittings the Mounting Bracket (SE240920) must be purchased separately.

Subject to technical changes

Asta Over Cabinet Light

FINISH:



aluminium

LED COLOUR:



cool warm

LAMP LIFE:



20,000
hours

DRIVER:



24V

RECOMMENDED LOCATION:



CABLE LENGTH:



1.5 metres

DIMMABLE:



BEAM ANGLE:



'optimum illumination of cabinet fronts'

- > Fitting has an adjustable head for optimum illumination of the cabinet front (adjusts by 30°).
- > Available in both cool white and warm white LED, allowing you to create the perfect mood lighting to suit your cabinetry.
- > 24 high definition LED diodes integrated in each fitting.
- > The 340mm head of the fitting ensures an even illumination across the cabinet front.
- > Can also be used above wardrobes.
- > A simple way to introduce mood lighting into the kitchen or bedroom.



Code	Wattage	LED Colour	Qty	Lumens	Driver	RRP
SE9015HDCW	1.65W	Cool White (5000K)	1	77 lm		£28.10
SE9015HDCWK2	3.3W	Cool White (5000K)	2	77 lm	6W included	£77.94
SE9015HDCWK3	4.95W	Cool White (5000K)	3	77 lm	6W included	£104.58
SE9015HDWW	1.65W	Warm White (3000K)	1	71 lm		£28.87
SE9015HDWWK2	3.3W	Warm White (3000K)	2	71 lm	6W included	£80.04
SE9015HDWWK3	4.95W	Warm White (3000K)	3	71 lm	6W included	£110.76

Accessories		
Code	Description	RRP
SE9009	2.5m Extension Cable	£2.64

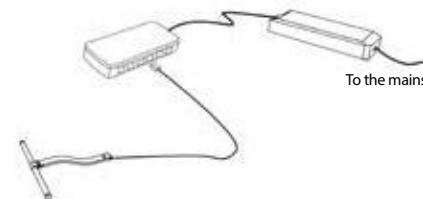
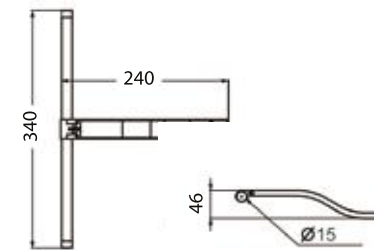

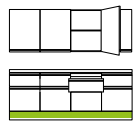

Plinth Lighting >



We've reformatted our plinth light packs...

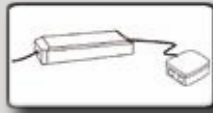

Run larger quantities from one driver

Packs include our 6W driver with 4 port JB4 distribution block (■ SE40553).



New pack sizes available

You can now choose from packs containing either 4 or 8 plinth lights to best suit your requirements. These packs include the suitable driver (■ SE40553).



*Makes buying and installing
Sensio plinth lights much simpler*

Applies to; Luce, Puro & Specto



Switch and dim with Sensio controllers

The plinth lights can now be used with the Sensio range of sensors/controllers and the Sensio Multi-Light App.



Single add-on units available

Order the exact number of plinth lights you need with the option of purchasing single add-ons.

Luce SLS LED Square Plinth Light

FINISH:



stainless steel

LED COLOUR:



cool warm

LAMP LIFE:



30,000
hours

DRIVER:



24V

RECOMMENDED LOCATION:



CABLE LENGTH:



2 metres

BEAM ANGLE:



130°

'invisible LED's'

- > The stainless steel surround provides a high quality finish.
- > The fitting has 3 concealed LED's integrated into the top edge to create a diffused light effect with no visible LED points.
- > Available as a 4 or 8 light pack, containing a 6W driver.
- > Individual fittings also available should you wish to have more than 8 fittings in a single run from one driver.
- > Light sits flush to the plinth for a sleek and stylish look.
- > Fittings daisy chain together for simple installation.
- > Suited to both contemporary and modern kitchens as you can choose from both cool white & warm white LED.
- > Compatible with Sensio 24V switches and dimmers.
- > The driver in the packs (SE40553) has a maximum allowance of 6W .
A maximum of 10 fittings can be run from the one driver (based on the fittings being daisy chained).



Code	Wattage	LED Colour	Lumens	Light Qty	Driver	RRP
SE15090C0	0.6W	Cool White (4000K)	16 lm	1	■	£5.50
SE15090W0	0.6W	Warm White (3000K)	16 lm	1	■	£5.50
SE15090C4	2.4W	Cool White (4000K)	16 lm	4	6W included	£39.06
SE15090W4	2.4W	Warm White (3000K)	16 lm	4	6W included	£39.06
SE15090C8	4.8W	Cool White (4000K)	16 lm	8	6W included	£61.87
SE15090W8	4.8W	Warm White (3000K)	16 lm	8	6W included	£61.87

SLS
surface light source

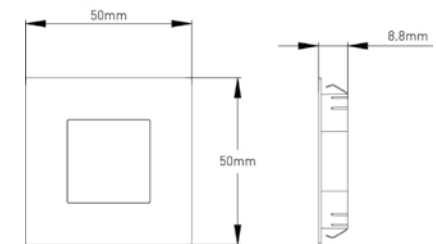

Cut-out size: Ø44mm

Luce single light fitting and SE40553 driver (which is included in the 4 & 8 light kits).

Plinth Lighting >

Specto LED Round Plinth Light

FINISH:



chrome

LED COLOUR:



cool warm

LAMP LIFE:



35,000
hours

DRIVER:



24V

RECOMMENDED LOCATION:



CABLE LENGTH:



1.5 metres

BEAM ANGLE:



90°

'stylish, discreet fitting, stunning effect'

- > Available as a 4 or 8 light pack, containing a 6W driver.
- > Individual fittings also available should you wish to have more than 8 fittings in a single run from one driver.
- > Each fitting runs at only 0.32W.
- > IP44 rated (protected against water splashes).
- > Ideal for use on the kitchen plinth or in zone 2 areas of the bathroom.
- > 15mm fittings – very discreet.
- > Chrome surround with an individual LED per fitting.
- > The fittings daisy chain together for simple installation.
- > Compatible with Sensio 24V switches and dimmers.
- > 6W driver included in the packs (SE40553) meaning a maximum of 18 fittings could be run from the one driver (based on fittings being daisy chained).



Code	Wattage	LED Colour	Lumens	Light Qty	Driver	RRP
SE15091C0	0.32W	Cool White (5500K)	8 lm	1		£5.88
SE15091W0	0.32W	Warm White (3000K)	8 lm	1		£5.88
SE15091C4	1.28W	Cool White (5500K)	8 lm	4	6W included	£42.12
SE15091W4	1.28W	Warm White (3000K)	8 lm	4	6W included	£42.12
SE15091C8	2.56W	Cool White (5500K)	8 lm	8	6W included	£65.64
SE15091W8	2.56W	Warm White (3000K)	8 lm	8	6W included	£65.64

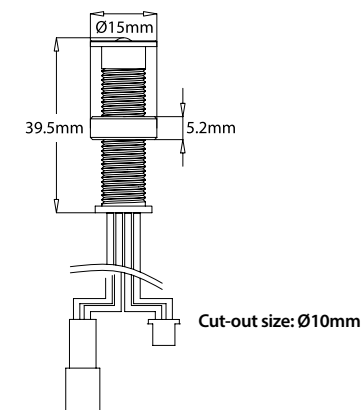

Specto single light fitting and SE40553 driver (which is included in the 4 & 8 light kits).

Puro LED Round Plinth Light

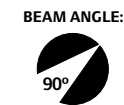
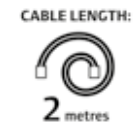
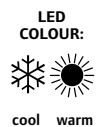

'compact & simple,
yet very effective'

- > Available as a 4 or 8 light pack, containing a 6W driver.
- > Individual fittings also available should you wish to have more than 8 fittings in a single run from one driver.
- > The fitting itself is completely transparent – the perfect invisible dot plinth lighting solution.
- > 15mm fittings – very discreet.
- > The fittings daisy chain together for simple installation.
- > 2 x 1 m cables per fitting.
- > Compatible with Sensio 24V switches and dimmers.
- > The driver in the packs (SE40553) has a maximum allowance of 6W .
A maximum of 25 fittings can be run from the one driver (based on the fittings being daisy chained).





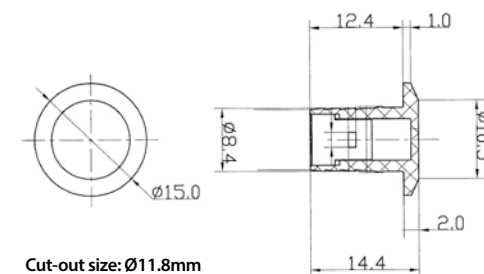

Code	Wattage	LED Colour	Lumens	Light Qty	Driver	RRP
SE15094C0	0.24W	Cool White (5500K)	10 lm	1	■	£4.54
SE15094W0	0.24W	Warm White (3000K)	10 lm	1	■	£4.54
SE15094C4	0.96W	Cool White (5500K)	10 lm	4	6W included	£35.92
SE15094W4	0.96W	Warm White (3000K)	10 lm	4	6W included	£35.92
SE15094C8	1.92W	Cool White (5500K)	10 lm	8	6W included	£55.32
SE15094W8	1.92W	Warm White (3000K)	10 lm	8	6W included	£55.32



Puro single light fitting and SE40553 driver (which is included in the 4 & 8 light kits).

Nimbus LED Plinth Light Kit

FINISH:  stainless steel	LED COLOUR:  cool	LAMP LIFE:  50,000 hours	CABLE LENGTH:  1.5 metres	RECOMMENDED LOCATION: 	BEAM ANGLE:  90°
--	---	---	---	---	--

'mood lighting for the kitchen or bathroom'

- > IP67 rated fittings suitable for use on kitchens plinths or in bathrooms.
- > All components required are included in the pack (6 fittings and LED driver).
- > 2 x 500mm cables on each individual fitting. 1.5 metres of mains cable from the driver.
- > Quality stainless steel fitting.
- > The maximum walkover pressure is 100kg.
- > As well as using in a plinth, this fitting is also suitable for use in ceramic tiles, natural stone, hard wood or Quartz flooring.
- > Cool white LED, an ideal plinth lighting option for the contemporary kitchen design.
- > Low energy consumption, each fitting runs at only 0.3W.
- > The maximum wattage load of the driver in this pack is 8W.



Code	Wattage	LED Colour	Qty	Cable	Lumens	Driver	RRP
SE35000C6	1.8W	Cool White (5500K)	6	1m PF*	22.8 lm	8W included	£50.76

* PF - per fitting

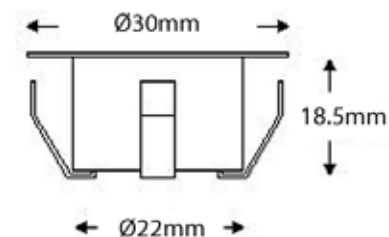

Cut-out size: Ø24mm



Flexible Strip Lighting >



An introduction to flexible strip lighting...

Flexible strip quick selection guide

There are a few things you need to know before selecting the best flexible strip for your design. Our quick selection guide below will help you make a quick and informed decision.

Design idea
Add depth to your kitchen by adding flexible strip lighting above wall units, along the plinth or under the work-top.

	Compact	Viva	Primo	DuoFlex	RGB
Maximum length of strip you can run from a single driver	8m	12m	13.75m	6m	10m
Available lengths	1m & 2m	333mm, 1m & 2m	5m	1m & 2m	330mm & 2m
LED colour	CW & WW	CW & WW	CW & WW	Mix CW & WW	RGB
Number of LED's	90	36	72	36/72	36
Brightness	540 lm	210 lm	342 lm	300 lm	180 lm
How many times the strip can be cut and re-used	Once	Once	Up to 50	None	None
Product section visual					



Figures are based on a 1m length, Cool White LED & using the largest driver available (or the maximum allowance). The RGB & DuoFlex can be cut however the cut section cannot be re-used.

Compact Multi-point LED Flexible Strip

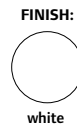

'more diodes, closer together - no dark spots'

- > A higher number of diodes per flexible strip means there are minimal dark spots. This provides a sleeker finish when used on a plinth in a kitchen with a glossy tiled floor or in an aluminium profile.
- > Self-adhesive 3M tape backing allows for quick and simple installation.
- > Male and female ends on the strip allow you to create the length required.
- > The strip can be cut to length, scissor marks on the product mark where suitable to cut (every 65mm).
- > Cut the strip ONCE and re-use the cut off piece using the mini-cut connector (SE90317HD).
- > Use this product for a variety of applications (on the plinth, on the underside of the bed, above cabinets/wardrobes to up-light the ceiling to name a few).
- > All you need to install is an adequate amount of flexible strips, driver connection lead(s) – one per run of strips and a LED driver.
- > Run 10m from one 60W driver.



Code	Wattage	Length	LED's	LED Colour	Lumens	Driver	RRP
SE20015C0.1	6W	1000mm	90	Cool White (5000K)	540 lm		£57.00
SE20015W0.1	6W	1000mm	90	Warm White (3000K)	500 lm		£57.00
SE20025C0.1	12W	2000mm	180	Cool White (5000K)	1026 lm		£115.44
SE20025W0.1	12W	2000mm	180	Warm White (3000K)	950 lm		£115.44

Packs (includes; 1 x flexible strip, 1 x driver connection lead & 1 x 15W driver).

SE20015C1.1	6W	1000mm	90	Cool White (5000K)	540 lm	included	£80.40
SE20015W1.1	6W	1000mm	90	Warm White (3000K)	500 lm	included	£80.40
SE20025C1.1	12W	2000mm	180	Cool White (5000K)	1026 lm	included	£138.72
SE20025W1.1	12W	2000mm	180	Warm White (3000K)	950 lm	included	£138.72

Compact - multi-point flexible strip



More diodes closer together to reduce dark spots

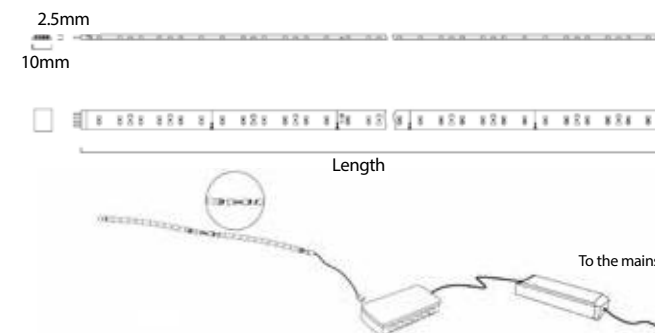

Cable & Connectors

HD LED Flexible Strip Driver Connection Lead – 2500mm - (SE90314HD) - £2.76
 Required to run the Compact LED Flexible Strip

HD LED Flexible Strip Inter-Connecting Lead – 500mm - (SE90315HD) - £2.52
 HD LED Flexible Strip Corner Connection Lead – 50mm - (SE90316HD) - £2.15
 HD LED Flexible Strip Cut Joining Connector - (SE90317HD) - £1.44
 2.5m Extension Cable - (SE9009) - £2.64



Subject to technical changes

Flexible Strip Lighting >

Viva LED Flexible Strip

FINISH:



LED COLOUR:



LAMP LIFE:



DRIVER:



RECOMMENDED LOCATION:



DIMMABLE:



BEAM ANGLE:



'can be used almost anywhere'

- > Self-adhesive 3M tape backing allows for quick and simple installation.
- > Male and female ends on the strip allow you to create the length required.
- > The strip can be cut to length, scissor marks on the product mark where suitable to cut (every 75-83mm).
- > Cut the strip ONCE and re-use the cut off piece using the mini-cut connector (SE10318MCC).
- > Extremely low energy consumption, only 5W per 2000mm.
- > Use this product for a variety of applications (on the plinth, on the underside of the bed, above cabinets/wardrobes to up-light the ceiling to name a few).
- > All you need to install is an adequate amount of flexible strips, driver connection lead(s) – one per run of strips and a LED driver.
- > Run a maximum length of 12m from one driver (based on using the 30W driver).



Code	Wattage	Length	LED's	LED Colour	Lumens	Driver	RRP
SE10310CW.1	0.8W	333mm	12	Cool White (5000K)	70 lm	■	£10.92
SE10310WW.1	0.8W	333mm	12	Warm White (3000K)	55 lm	■	£10.92
SE10312CW.1	2.5W	1000mm	36	Cool White (5000K)	210 lm	■	£28.32
SE10312WW.1	2.5W	1000mm	36	Warm White (3000K)	165 lm	■	£28.32
SE10311CW.1	5W	2000mm	72	Cool White (5000K)	420 lm	■	£55.92
SE10311WW.1	5W	2000mm	72	Warm White (3000K)	330 lm	■	£55.92

Packs (includes; 1 x flexible strip, 1 x driver connection lead & 1 x 6W or 15W driver).

SE10312CWK1.1	2.5W	1000mm	36	Cool White (5000K)	210 lm	included	£49.92
SE10312WWK1.1	2.5W	1000mm	36	Warm White (3000K)	165 lm	included	£49.92
SE10311CWK1.1	5W	2000mm	72	Cool White (5000K)	420 lm	included	£84.96
SE10311WWK1.1	5W	2000mm	72	Warm White (3000K)	330 lm	included	£84.96

2m Flexible LED Strip Light



SE10318MCC Cut Joining Connector

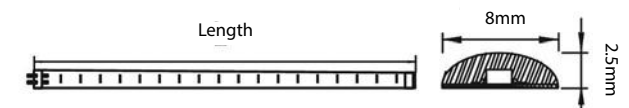

Cables/Accessories



Cable & Connectors

LED Flexible Strip Driver Connection Lead – 2500mm - (SE10314) - £2.52
Required to run the Viva Flexible LED Strip Light.

LED Flexible Strip Corner Connection Lead – 50mm - (SE10316) - £2.04
LED Flexible Strip Inter-Connecting Lead – 500mm - (SE10315) - £1.44
LED Flexible Strip Inter-Connecting Lead – 1500mm - (SE10317) - £2.40

Accessories

LED Flexible Strip Cut Joining Connector (SE10318MCC) - £1.20
2.5m Extension Cable - (SE9009) - £2.64

Primo

5m Clip LED Flexible Strip



'cut and reconnect up to 50 times!'

- > This customisable flexible strip allows you to illuminate several areas of a room using just one strip.
- > Supplied as a 5m reel.
- > The strip can be cut every 100mm, scissor marks on the product mark where suitable to cut.
- > The strip has connection points every 100mm. When cutting the strip and reconnecting or connecting the first strip; slide the strip into the clip connector so the connectors sit under the 2 prongs and push down the clip head. (Ensure the polarity is correct as you do this).
- > Each reel is supplied with 3M self-adhesive backing and Silicon fixing clips for secure installation.
- > Use this versatile product for a variety of applications.
- > All you need to install is a 5m Primo reel, driver connection lead(s) – one per run of strips and a LED driver.



Code	Wattage	Length	LED's	LED Colour	Lumens	Driver	RRP
SE1005C0	18W	5m	357	Cool White (5000K)	1709 lm		£91.56
SE1005W0	18W	5m	357	Warm White (3000K)	1555 lm		£91.56

Packs (includes; 1 x Primo flexible strip, 1 x driver connection cable & 1 x 30W driver).

SE1005C1	18W	5m	357	Cool White (5000K)	1709 lm	included	£131.28
SE1005W1	18W	5m	357	Warm White (3000K)	1555 lm	included	£131.28

Primo - 5m Clip Flexible Strip Reel



The strip has connection points every 100mm, the strip can be cut at each of these points. When cutting the strip and reconnecting or connecting the first strip; slide the strip into the clip connector so the connectors sit under the 2 prongs, and push down the clip head. (Ensure the polarity is correct as you do this).

Cable & Connectors

Primo 2.5m Driver Connection Cable - (SE101080) - £4.08
Required to run the Primo Flexible Strip

Primo Interconnecting Clip - (SE100050) - £1.44
 Primo 50mm Corner Connector - (SE101050) - £2.40

2.5m Extension Cable - (SE9009) - £2.64



SE100050



SE101050



SE101080

Flexible Strip Lighting >

DuoFlex Flexible Strip



'seamlessly mix colour to create the perfect mood'

- > The DuoFlex brings real flexibility to the flexible strip light range. With only one flexible strip the LED colour can be set from warm white through the full spectrum to cool white.
- > Self-adhesive 3M backing allows for quick and simple installation.
- > Male and female ends on the strip allow you to create the length required.
- > The strip can be cut to length, scissor marks on the product mark where it is suitable to cut (every 165mm). The strip can be cut once and once cut that is the end of the run. The cut piece with the female end cannot be reused.
- > Operate using a remote control or Sensio Multi-Light app. One remote will control all receivers within a 15m radius.
- > A maximum length of 6m of the DuoFlex can be run from each receiver.
- > Ten brightness levels of the LED, dim or brighten in 10% increments.
- > The wattage of the driver included in the packs is 30W.



Main image shows the DuoFlex set to cool white

Code	Wattage	Length	LED's	Colour Temp.	Lumens	Driver	RRP
SE10011D0	3.75W	1000mm	72	2700-5000K	282-300 lm		£46.68
SE10021D0	7.5W	2000mm	144	2700-5000K	282-300 lm		£88.20

Packs

Code	Wattage	Length	Cable	Controller	Driver	RRP
SE10073D1	7.5W	2000mm	2 x 2.5m	Remote & Receiver	included in pack	£153.96

SE1003000 - DuoFlex Remote Control (see page 60 for details)

SE1004100 - DuoFlex Receiver (see page 60 for details)

Cool white & warm white diodes side by side. The strip is marked at intervals where it can be cut.



From top to bottom: warm white LED, natural white LED and cool white LED.

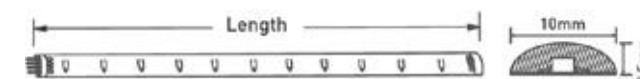

Cables/accessories

Driver Connection Lead – 2500mm - (SE10325) - £3.96
One driver lead is required for each run of the DuoFlex.

DuoFlex Inter-Connecting Lead – 500mm (SE10328) - £2.88
 DuoFlex Corner Connection Lead – 50mm (SE10327) - £2.64

DuoFlex Remote Control

'control both LED colour and brightness'

- > The DuoFlex remote control allows you to choose from both cool white and warm white LED, or to create a natural white tone by mixing the two colours.
- > One remote can control multiple receivers (as many as you require, within a 15m radius), allowing you to control DuoFlex located in different areas of the kitchen.
- > Functions of the DuoFlex remote control:
 - Rotate the colour temperature wheel to select the desired colour temperature.
 - Decrease the brightness level of the DuoFlex strips (in 10% increments).
 - Increase the brightness level of the DuoFlex strips (in 10% increments).
 - On/off – switch the connected fittings on/off.
 - Memory function of the last setting before switched off.
 - Radio Signal - the maximum range of the remote control is 15m.



Code	Product Description	Max. Wattage	Driver	RRP
SE1003000	DuoFlex Remote Control	n/a	■	£24.70
SE1004100	DuoFlex Receiver	22.5W per receiver	■	£34.20

The SE40555 15W driver will run a maximum of 4m of the DuoFlex.
 The SE40556 30W driver will run a maximum of 6m of the DuoFlex.

The maximum length of the DuoFlex which can be run from one DuoFlex receiver is 6m.

NB: When buying the DuoFlex flexible strip lighting, you require a driver, driver connection lead and remote control for each run of strips. These are purchased separately (unless buying in a pack). One receiver is required for each driver.

To control the DuoFlex Flexible Strip from your phone see page103.

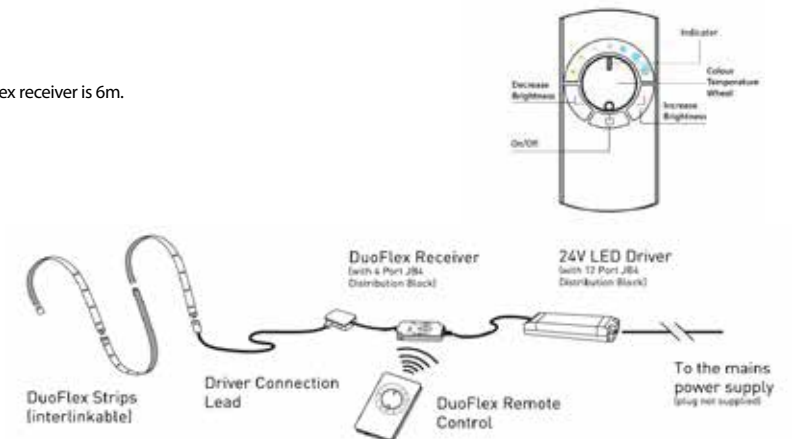
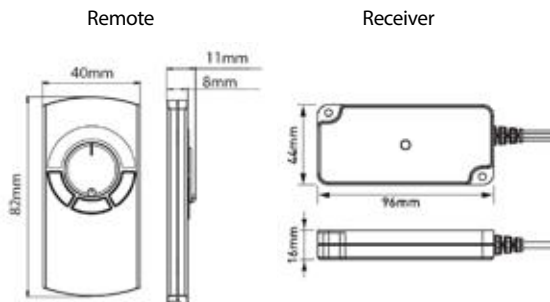

RGB Colour Changing Flexible Strip

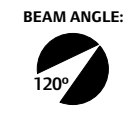
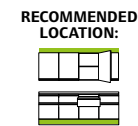
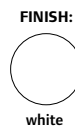

'7 colours, 3 effects'

- > Self-adhesive 3M tape backing allows for quick and simple installation.
- > 7 preset colours of the RGB (cool white, violet, yellow, cyan, green, red and blue).
- > The perfect product to create mood lighting, either set to one of the 7 colours, or select the slow or rapid colour change option.
- > Male and female ends on the strip allow you to create the length required.
- > The strip can be cut to length, scissor marks on the product mark where suitable to cut (every 162mm).
- > Use the RGB remote control or Sensio Multi-Light app to create the effect or choose the colour that is perfect for you at the touch of a dial.
- > All you need to install is an adequate amount of flexible strips, driver connection lead(s) – one per run of strips, driver and a RGB control.
- > Run a maximum length of 12m from a 60W driver.
- > When using the RGB remote control, each new run of RGB strip lighting requires a driver and a receiver, however multiple receivers can now be controlled via one remote control.



Code	Wattage	Length	LED Colour	No. of LED's	Driver	RRP
SE10005R0	1.8W	330mm	RGB	12pcs		£12.10
SE10025R0	10W	2000mm	RGB	72pcs		£75.24

Pack

Code	Wattage	Length	Cable	Includes	RRP
SE10160R1	10W	2000mm	2 x 2.5m	1 x 30W Driver, 1 x Receiver & 1 x Remote	£200.40

LED RGB Colour Changing Flexible Strip Light



SE793990 - RGB LED Bluetooth Receiver for Sensio Multi-Light Control app. **See page 103.**

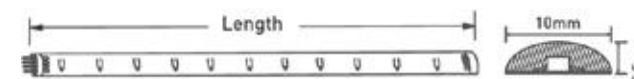

Cables/Accessories



Cables/Accessories

LED RGB Flexible Strip Driver Connection Lead - 2500mm (SE10325) - £3.96
Required to run the RGB LED flexible Strip

LED RGB Flexible Strip Corner Connection Lead - 50mm (SE10327) - £2.64
 LED RGB Flexible Strip Inter-Connecting Lead - 500mm (SE10328) - £2.88

RGB Remote Control

'quickly and easily set the mood'

- > Create the effect or choose a single colour that is perfect for you.
- > Multiple receivers can be controlled from one remote control (all receivers within a 15m radius of the remote at any one time).
- > 24V system allows for 60W of RGB product to be run per receiver.
- > Functions of the RGB remote control:
 - Single colour mode – select one colour by rotating the wheel
 - Gradual colour change – light colour gradually changes
 - Flashing colour change mode – light colour rapidly changes
 - Colour change speed – change the speed at which the colours change
 - Brightness level – change through the 3 brightness levels of the RGB
 - On/off – switch the connected fittings on/off
- > Memory function of the performance before last switched off.
- > Radio Signal - Maximum range of controller is 15m.
- > The remote control is powered by a 3V button lithium battery (supplied).



Code	Product Description	Max. Wattage	Driver	RRP
SE791090	RGB Remote Control	n/a	■ ■	£39.00
SE791050	RGB Receiver	30W/60W per receiver	■ ■	£28.08

NB: reference the maximum wattages stated above, the lower value relates to 12V (orange) and the higher value, 24V (green).

When buying Sensio RGB lighting, you require a driver, driver connection lead and controller (either Remote or Sensio Multi-Light app & Receivers) for each run of strips. These are purchased separately (unless buying in a pack). One receiver is required for each driver.

RGB Remote Control



RGB Remote Control

Single colour; gradual colour change; rapid colour change; change colour change speed; dim; on/off

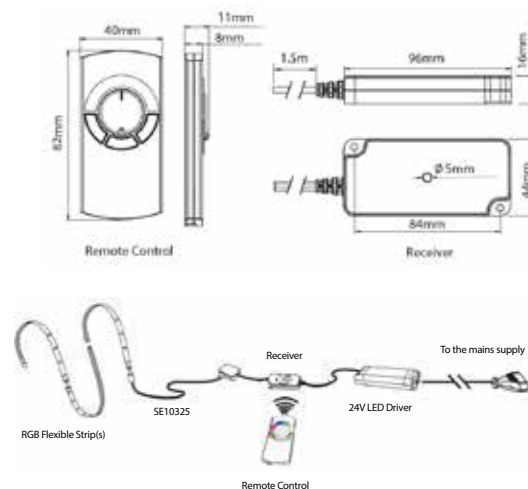
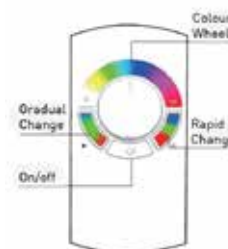

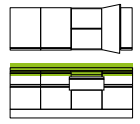

Aluminium Profiles >



Linia

Recessed Aluminium Profile

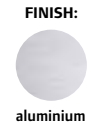

'flush fit for a minimalist look'

- > The Linia has been specially redesigned with an increased width and depth to house all of our single colour, RGB and Dual colour flexible strip lights from the Sensio range, allowing you to create your perfect lighting solution.
- > The diffuser has been manufactured from more flexible material so it is much easier to install.
- > We have redesigned the Linia end caps to be round that protrude from the fitting to fill the gap in the furniture when cut with a router for a much neater finish – end caps and mounting brackets supplied with each profile. The 1m profile has 2 mounting brackets and the 2.2m profile has 4.
- > Perfect for use under kitchen cabinets, inside larders or inside wardrobes.
- > Use with one of our in cabinet sensor switches (pages 108 & 109) when using inside a larder or cabinet so the light switches on/off as the door opens/closes
- > The aluminium lip either side of the fascia has been reduced for a more streamlined finish.
- > A versatile solution as both the profile and flexible strip can be cut to length.



Code	Length	LED Strip	Cable	Driver	RRP
SE980120	1000mm	Profile only	N/A	N/A	£11.76
SE980220	2200mm	Profile only	N/A	N/A	£23.76

Flexible Strip Lighting sold separately - see pages 56-61 for options.

Accessories		
Code	Description	RRP
SE980050	2 x End caps for Recessed Profile	£0.84
SE981050	2 x Mounting Brackets for Surface Mounted/Recessed Profile	£0.48

Recessed Aluminium Profile



End caps and mounting brackets included

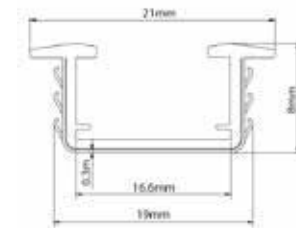
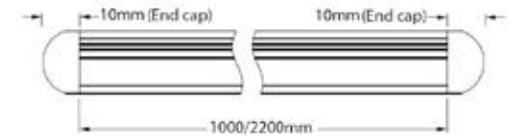

Cut-out
Width: 18mm (without bracket)
19mm (with bracket)
Depth: 6.5mm



SE980050



SE981050

Fino

Surface Mounted Profile



'customisable lighting'

- > The Fino has been specially redesigned with an increased width and depth to house all of our single colour, RGB and Dual colour flexible strip lights from the Sensio range, allowing you to create your perfect lighting solution.
- > Use the Compact or Primo flexible strip lights which have more diodes packed tightly together to create a more diffused lighting effect.
- > The diffuser has been manufactured from more flexible material so it is much easier to install.
- > End caps and mounting brackets supplied with each profile. The 1m profile has 2 mounting brackets and the 2m profile has 4.
- > The Fino and flexible strip range can be cut to length making this an extremely versatile solution – perfect when you have bespoke sizes to meet.
- > Whilst aluminium profiles are great for their aesthetic qualities, they are also very useful for extending the life of your LED strips.
- > Butt lengths of the profile together if a longer run is required.
- > Great for using under or inside kitchen cabinets and inside wardrobes.



Code	Length	LED Strip	Cable	Driver	RRP
SE981120	1000mm	Profile only	N/A	N/A	£11.28
SE981220	2000mm	Profile only	N/A	N/A	£21.24

Flexible Strip Lighting sold separately - see pages 56-61 for options.

Accessories		
Code	Description	RRP
SE982050	2 x End caps for Surface Mounted Profile	£0.84
SE981050	2 x Mounting Brackets for Surface Mounted/Recessed Profile	£0.48

Surface Mounted Aluminium Profile



End caps and mounting brackets included

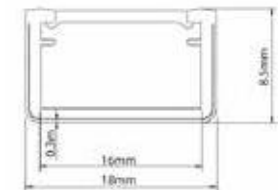
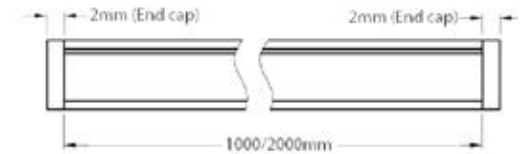

SE982050



SE981050

Sensio Midway Hanging Rail

Award Winning
Our Midway Hanging Rail won a Silver Award for Best Lighting in the House Beautiful 2016 Awards and won in the 'Innovation in Functionality' category for the Designer Kitchen and Bathroom Awards 2016.

The ultimate solution for kitchen organisation and illumination

- Illuminated hanging rail system to be mounted midway between the wall units and the work surface.
- A unique Sensio product design.
- Build your own solution:
 - Four accessories available; large shelf, small shelf, utensil holder & kitchen roll holder.
 - Pick any single colour flexible strip from the range to include inside the profile.
- Keep worktops clear and necessities to hand.
- Designed, developed, perfected.



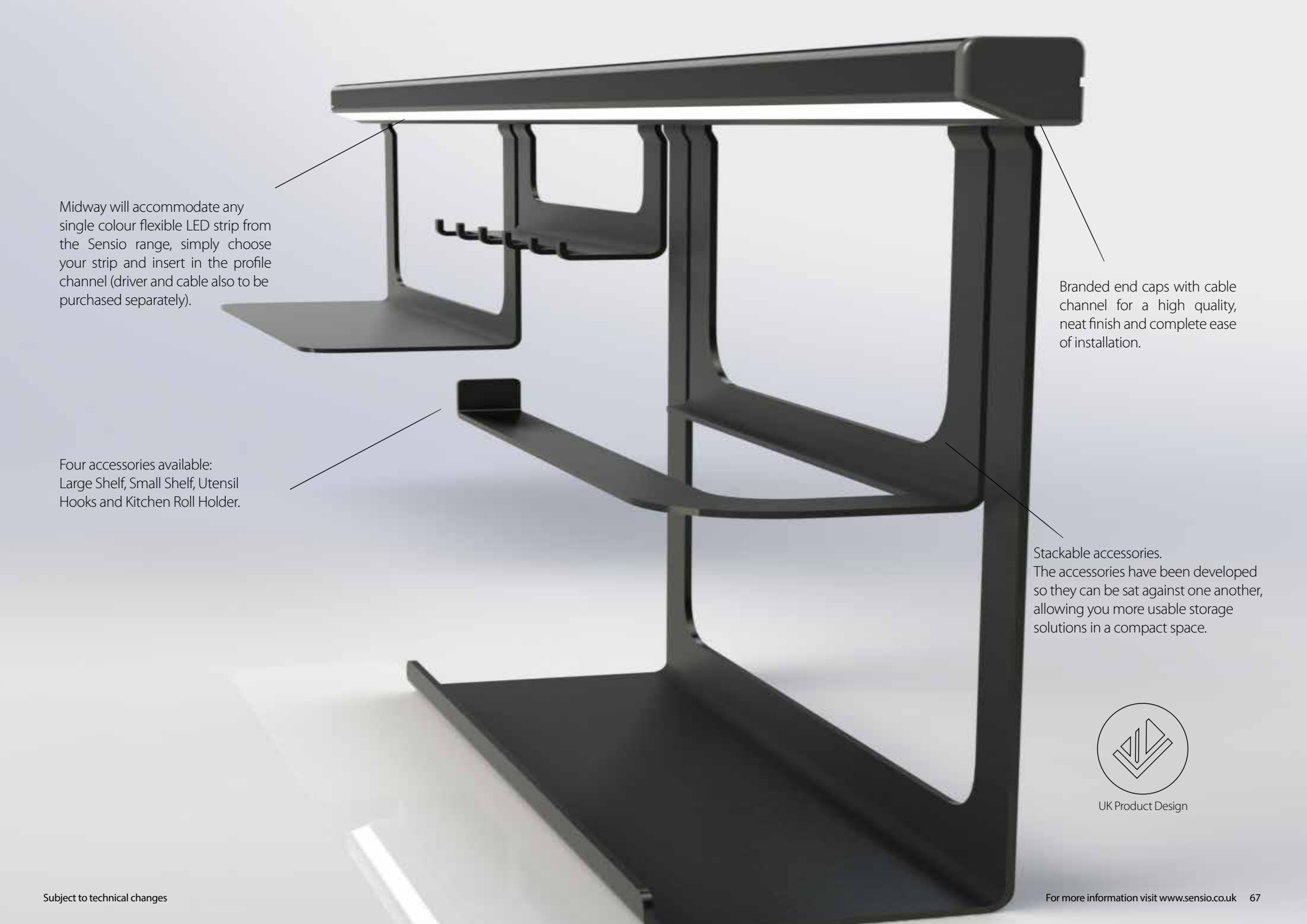

Midway will accommodate any single colour flexible LED strip from the Sensio range, simply choose your strip and insert in the profile channel (driver and cable also to be purchased separately).

Four accessories available: Large Shelf, Small Shelf, Utensil Hooks and Kitchen Roll Holder.

Branded end caps with cable channel for a high quality, neat finish and complete ease of installation.

Stackable accessories. The accessories have been developed so they can be sat against one another, allowing you more usable storage solutions in a compact space.



UK Product Design

Sensio Midway V1 Hanging Rail System



'kitchen organisation at its best'

- > Midway allows you to utilise the space between your wall units and worktop, providing task lighting and that essential additional storage space.
- > Build your perfect solution.
- > Designed by Sensio in the UK this is a completely unique product.
- > Two finishes of the Midway rail and accessories available; silver or black.
- > Four initial accessories available; kitchen roll holder, utensil holder, small shelf and large shelf.
- > The profile is available in a 1m* length, however if a longer length is required simply butt two profiles alongside one another.
- > Choose any single colour flexible strip from the Sensio range and simply slot into the profile channel.
- > The profile can be cut to length (ensure chosen accessories fit if you do cut).
- > The profile and accessories have an extremely high quality finish.
- > The cable can come through either the left or right side of the profile
- > Branded end caps included.



Code	Length	LED Strip	Cable	Driver	RRP
SE180221	1m*	Profile only	N/A	N/A	£44.64
SE18012C1	1m*	SE20015C0 included	2.5m included	6W included	£130.08

Flexible Strip Lighting sold seperately - see pages 56-61 for options.
Or buy the kit above which contains the Compact Flexible Strip, cable and driver.

*The profile measures at 1015mm without end caps and 1025mm with end caps.

Accessories		
Code	Description	RRP
SE180520	Small Shelf	£44.40
SE180620	Large Shelf	£57.60
SE180720	Utensil Hooks	£31.68
SE180920	Kitchen Roll Holder	£41.40
SE180420	Silver End Caps for Midway	£2.40
SE180320	Midway System Profile Clips	£2.40



Midway Profile

Kitchen Roll Holder



Utensil Hooks



Small Shelf



Large Shelf

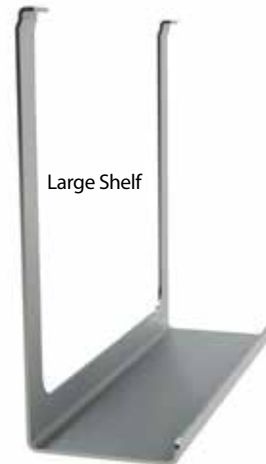

UK Product Design

Sensio Midway V1 Hanging Rail System



Kitchen Roll Holder

Utensil Hooks

Small Shelf

Large Shelf

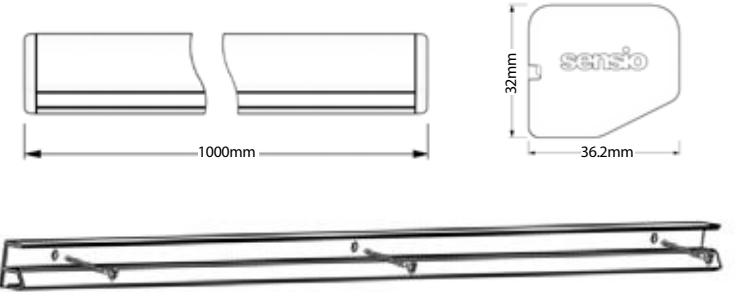

The profile is extremely simple to install

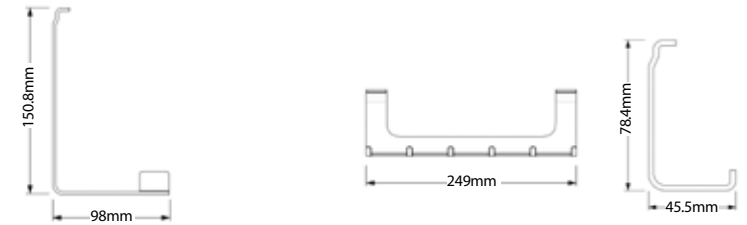

Kitchen Roll Holder

Utensil Hooks

Code	Length	LED Strip	Cable	Driver	RRP
SE180821	1m*	Profile only	N/A	N/A	£44.64
SE18018C1	1m*	SE20015C0 included	2.5m included	6W included	£130.08

Flexible Strip Lighting sold separately - see pages 56-61 for options.
Or buy the kit above which contains the Compact Flexible Strip, cable and driver.

*The profile measures at 1015mm without end caps and 1025mm with end caps.

Accessories

Code	Description	RRP
SE180530	Small Shelf	£44.40
SE180630	Large Shelf	£57.60
SE180730	Utensil Hooks	£31.68
SE180930	Kitchen Roll Holder	£41.40
SE180430	Black End Caps for Midway	£2.40
SE180320	Midway System Profile Clips	£2.40

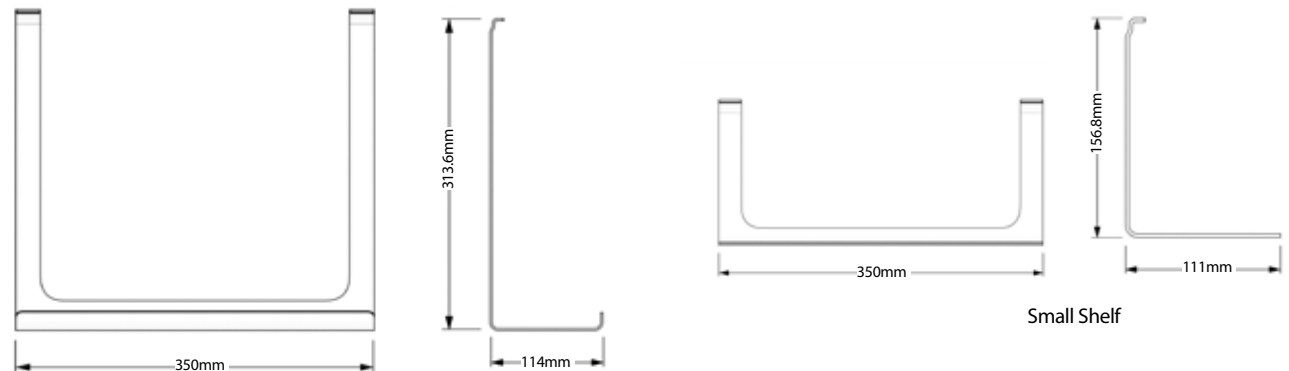

Large Shelf

Small Shelf

Dimensional drawings apply to both the silver and the black finish

Ceiling Lighting >



IP65 GU10 Fire Rated Ceiling Spot Light

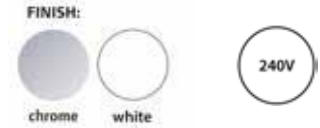

'complete your lighting scheme'

- > This fire rated fitting has intumescent properties to restore the fire integrity of the surface surrounding the cut out in the event of a fire.
- > This fitting has a 90 minute fire rating.
- > GU10 fitting. Runs at 240V so no external transformer or driver is required.
- > Available in a choice of 2 finishes; white or chrome.
- > Choose the finish you require then select the LED lamp you'd like choosing from cool white or warm white LED.
- > The lamp itself sits close to the glass for an increased beam angle.
- > Part B/C/E compliant.
- > IP65 rated fitting.



* Lamps not included with the fittings - purchase separately

Code	Finish	Power Supply	IP Rating	Cut out	RRP
SE30034W0.1	White	240V	IP65	75mm	£17.51
SE30042W0.1	Chrome	240V	IP65	75mm	£19.91

Lamps

Code	Wattage	LED Colour	Lumens	Beam angle	RRP
SE37105C0.1	5W	Cool White (6000K)	400 lm	37°	£8.69
SE37105W0.1	5W	Warm White (2500K)	310 lm	37°	£8.69



SE30034W0.1

SE30042W0.1

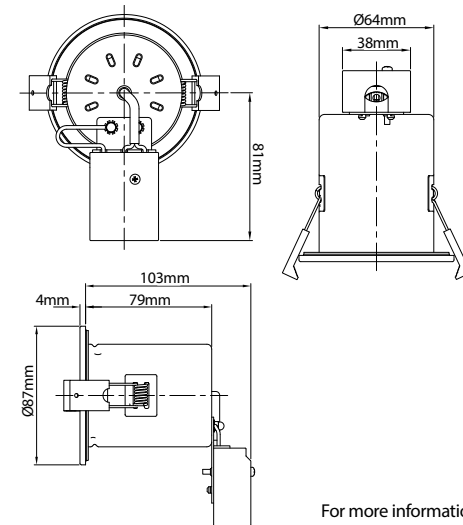

GU10 Dimmable COB LED Lamp



Zirconia Crystal Cone Pendant Light

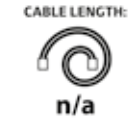

'a drop of style'

- > Inject desirable mood lighting into your kitchen or bedroom with this exquisite droplet pendant finished in chrome and complete with a clear base laced with floating crystals.
- > The LED's bounce and reflect light from the crystals to provide a sparkling light that cascades down.
- > The 24 integrated LED's have a lifespan of 30,000 hours.
- > Combine the Zirconia pendant light with ceiling spotlights to provide both ambient and task lighting to your kitchen.
- > The pendant is suspended on a 920mm stainless steel cable which is adjustable so you can tailor the piece to fit according to your ceiling height.
- > This pendant looks stunning on its own or in a cluster with two or three fittings next to each other.
- > The Zirconia has been designed to be used above a kitchen island, dining table or in the bedroom. Use one either side of the bed above the bedside tables for the perfect finishing touch, this also works well if you have limited space for table lamps in that area of the room.
- > This pendant is IP44 rated so is suitable for use in the bathroom.



Code	Wattage	LED Colour	Lumens	Power Supply	RRP
SE32101W0	4.8W	Warm White (3000K)	330 lm	240V	£133.18

Design idea
Layer 3 Zirconia pendants at different heights over a kitchen island or dining table to inject on-trend style into your kitchen design.



Chrome base of the fitting



Crystal segment of the pendant

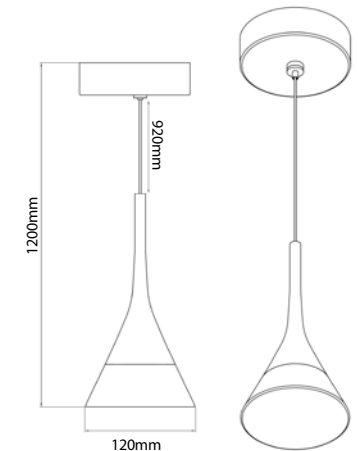

Bellatrix Crushed Crystal Pendant Light



'add glamour to your kitchen design'

- > This amazing pendant light features a polished chrome finish with a beautiful crushed crystal layer that sits on the bottom of the fitting.
- > The Bellatrix pendant has 972 integrated LED's that bounce light off of the crystals to create a stunning sparkling light effect whilst providing superbly bright illumination.
- > The pendant is dimmable so you can adjust the brightness as required.
- > The integrated LED's have a lifespan of 30,000 hours.
- > The pendant is suspended on 1.1m stainless steel cables which are adjustable so you can tailor the piece to fit according to your ceiling height.
- > The Bellatrix is guaranteed to be the centre of attention and looks stunning when suspended above a kitchen island or dining table.
- > This pendant is IP44 rated so is suitable for use in the bathroom.



Code	Wattage	LED Colour	Lumens	Power Supply	RRP
SE32001W0	33.12W	Warm White (3000K)	2000 lm	240V	£812.20

SE32001W0 - On and Off



Crystal segment of the pendant

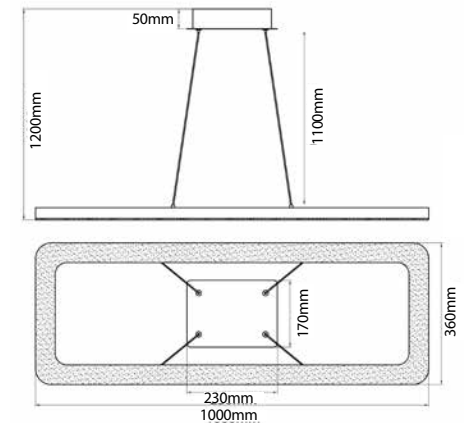

Wireless Charging >



Qi Wireless Charger

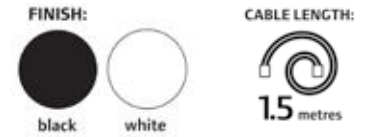

'integrated wireless charging for the kitchen'

- > Integrate into the work surface for a flush fit, discreet and convenient wireless charging solution.
- > Simply sit any Qi enabled mobile device on top of the charger. If your device does not have Qi built-in an additional interface is required (see options below).
- > Removes the need for power cords. Simply place your phone on the charger for convenient charging whilst you're cooking or entertaining.
- > Charging distance 0-6mm.
- > Two finishes available; black and white. The white finish option has a silver finish around the edge of the fitting.
- > The charger must be fitted with a 25mm clearance from the edge of the work surface. The maximum worktop depth this item is suitable for is 60mm.
- > The lip is only 1mm deep for a completely flush fit.
- > Input: DC 5V - 1.5A. Output: DC 5V - 1A.



Code	Finish	Connection	Wattage	RRP
SE870980	Black	Micro USB cable (plug not included)	5W	£67.92
SE870990	White	Micro USB cable (plug not included)	5W	£67.92

Phone cases				
SE871980	Qi Wireless Charging Receiver Phone Case (Black) - iPhone 5s			£51.11
SE872980	Qi Wireless Charging Receiver Phone Case (Black) - iPhone 6			£51.11

Accessories				
SE2007000	Pluggable USB Charger with 5m cable			£11.76

The charger above is to be purchased if you require a longer cable than the 1.5m supplied. This also comes with a plug should you not have a suitable adapter.

Subject to technical changes



SE870980



SE870990



SE871980



A phone case is only required for mobile devices which do not have Qi capabilities built in.

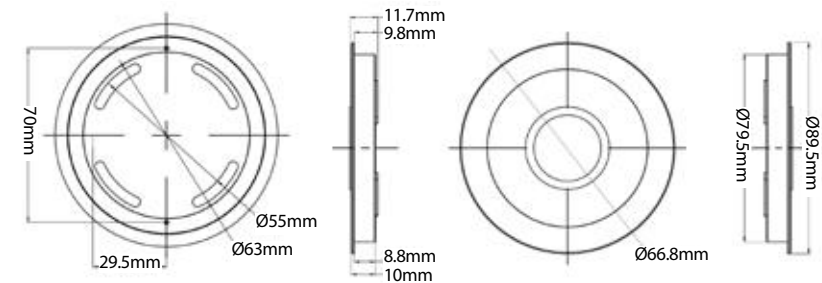

80mm diameter hole cut required

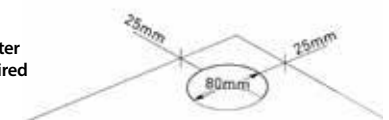

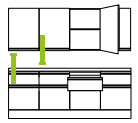

SensioPod >



SensioPod >

SensioPod Pull up Socket

FINISH:
aluminium

RECOMMENDED LOCATIONS:
> worktop
> centre islands
> under cabinet (pull down)

CABLE LENGTH:
2.5 metres

'great for usb charging'

- > Two USB ports integrated to charge the latest USB devices. The maximum allowance across both USB ports is 2100mA.
- > Slim profile design with aluminium casing.
- > This product has a specially designed chrome handle which makes it simple to pull the fitting up.
- > IP54 rated with inbuilt water channels, protected against splashing water.
- > Quick release catch to guarantee the unit will always close securely.
- > Neon green control switch provides a simple means of checking appliances have been turned off when not in use to save on energy bills.
- > Visible plugs and unsightly cables will no longer be seen as the SensioPod can be retracted fully whilst products are still plugged in.
- > No need to access the fuse under the plinth should it need changing, as the fuse is built into the model below the on/off switch.



Code	Finish	Connection	Sockets	RRP
SE80050AL	Aluminium Effect	13A plug included	3 x power & 2 x USB	£90.97

Please note: if charging a Smart device with a high mA requirement, please only charge one item at any one time.

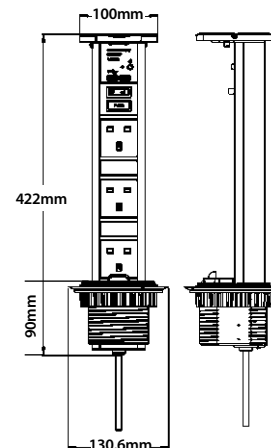
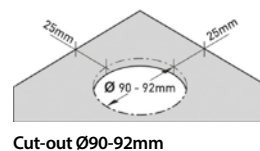

Fuse Cover



IP54 Rated

SensioPod+ Pull up Socket

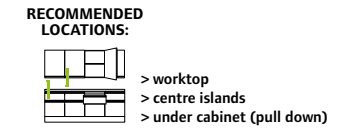
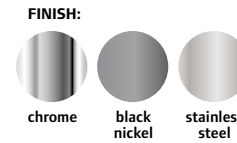

'slim profile, contemporary finishes'

- > Die cast metal top in a choice of three finishes, Chrome, Black Nickel and Stainless Steel.
- > Two USB ports integrated to charge the latest USB devices. The maximum allowance across both USB ports is 2100mA.
- > Aluminium casing and slim profile design.
- > IP54 rated with inbuilt water channels, protected against splashing water.
- > Quick release catch to guarantee the unit will always close securely.
- > Neon green control switch provides a simple means of checking appliances have been turned off when not in use to save on energy bills.
- > Visible plugs and unsightly cables will no longer be seen as the SensioPod+ can be retracted fully whilst products are still plugged in.
- > No need to access the fuse under the plinth should it need changing, as the fuse is built into the model below the on/off switch.



SE80050CH

Code	Finish	Connection	Sockets	RRP
SE80050CH	Chrome	13A plug included	3 x power & 2 x USB	£140.64
SE80050GM	Black Nickel	13A plug included	3 x power & 2 x USB	£140.64
SE80050SS	Stainless Steel	13A plug included	3 x power & 2 x USB	£140.64

Please note: if charging a Smart device with a high mA requirement, please only charge one item at any one time.

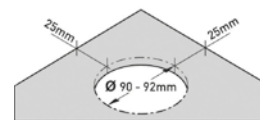

Cut-out Ø90-92mm

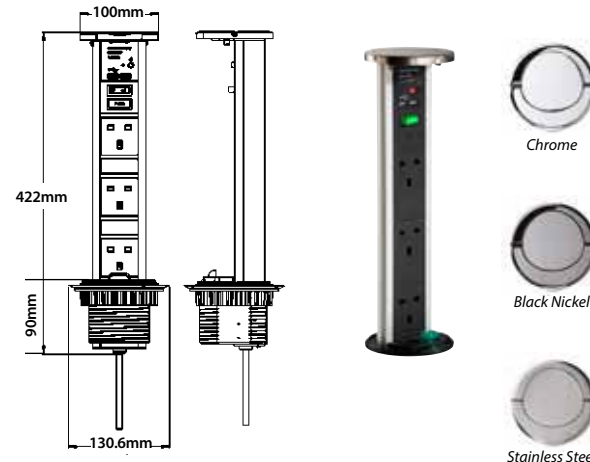

SE80050GM - Black Nickel



SE80050SS - Stainless Steel

SensioPod >

SensioPower R Recessed Power Socket & USB

FINISH:

stainless steel

RECOMMENDED
LOCATION:

CABLE LENGTH:

1.5 metres

'flush fit hidden power point'

- > The perfect discreet single socket power solution, perfect if you have minimal void space available below the worktop.
- > Two USB ports for mobile phone & iPod charging.
- > Stainless steel finish top for a high quality finish.
- > Alternatively use this product in the side panel of an island.
- > Neat finish. The lip of the product which sits on top of the work surface is only 5mm.
- > The depth of the steel lid itself is only 1mm.
- > The hinged lid is magnetised and simply lifts up. The lid will remain upright until closed if mounted in a worktop.
- > Illuminated red power icon provides a simple means of indicating whether there is power being supplied to the product.
- > Suitable for use in kitchens, bedrooms or home office.



Code	Finish	Connection	Sockets	RRP
SE890900	Stainless Steel	13A plug included	1 x power & 2 x USB	£81.60

Please note: if charging a Smart device with a high mA requirement, please only charge one item at any one time.

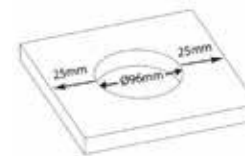
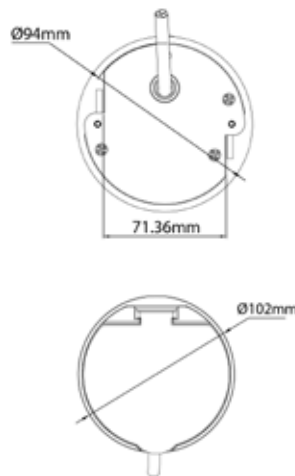

Cut-out Ø96mm



SensioPod Bluetooth Pull up Socket

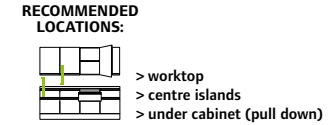

'perfect for the modern living kitchen'

- > The first SensioPod pull up socket with an in-built Bluetooth speaker.
- > Add a touch of luxury to your kitchen designs with this exclusive product.
- > Perfect for an open plan living space which is used for cooking, dining, entertaining and spending time with family.
- > Multi-functional product; power, Bluetooth audio and USB.
- > Two USB ports (with a combined max. allowance of 2100mA) for charging the latest mobile devices.
- > Aluminium casing, slim profile and steel finish top to give a high end look.
- > Specially designed handle makes it simple to pull the fitting up.
- > IP54 rated with inbuilt water channels, protected against splashing water.
- > Quick release catch to guarantee the unit will always close securely.
- > Neon green switch provides a simple means of checking appliances have been turned off when not in use to save on energy bills.
- > Visible plugs and unsightly cables will no longer be seen as the SensioPod can be retracted fully whilst products are still plugged in.



Code	Connection	Features	RRP
SE890920	13A plug included	2 x power sockets, Bluetooth speaker & 2 x USB ports	£201.17

Audio specifications:

- > 2W miniature audio speaker
- > Sensitivity at L/R380MV
- > SNR > 80db
- > Frequency range: 280Hz-16KHz
- > Suitable for use with any Bluetooth enabled audio device and 3.5mm headphone jack (including MP3, MP4, Android Smart phones, iPhone's and iPad).



Please note: if charging a Smart device with a high mA requirement, please only charge one item at any one time.

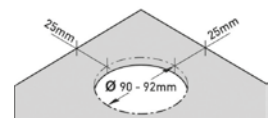

Cut-out Ø90-92mm

SensioPower U Bluetooth Power System with Shelf



'everything you need for the kitchen of today'

- > Add a touch of luxury to your kitchen designs with this exclusive product.
- > Multi-functional product; power, Bluetooth audio, hanging rail and USB.
- > Mount under kitchen wall units.
- > Place your iPad or cookbook on the aluminium hanging shelf when cooking or baking.
- > Two power sockets and Bluetooth audio; plug your appliances in and wirelessly play your music whilst cooking or entertaining through a single device.
- > Perfect for an open plan living space which is used for cooking, dining, entertaining and spending time with family.
- > Two USB ports (with a combined max. allowance of 2100mA) for charging the latest mobile devices.
- > Aluminium finish of the power unit and hanging rail for a high end look.
- > IP54 rated so the product is not affected by splashing water or steam.
- > Neon green switch provides a simple means of checking appliances have been turned off when not in use to save on energy bills.



Code	Connection	Features	RRP
SE891920	13A plug included	2 x power sockets, Bluetooth speaker, 2 x USB ports & hanging shelf	£187.57

Audio specifications:

- > 2W miniature audio speaker
- > Sensitivity at L/R380MV
- > SNR > 80db
- > Frequency range: 280Hz-16KHz
- > Suitable for use with any Bluetooth enabled audio device and 3.5mm headphone jack (including MP3, MP4, Android Smart phones, iPhone's and iPad).



Please note: if charging a Smart device with a high mA requirement, please only charge one item at any one time.

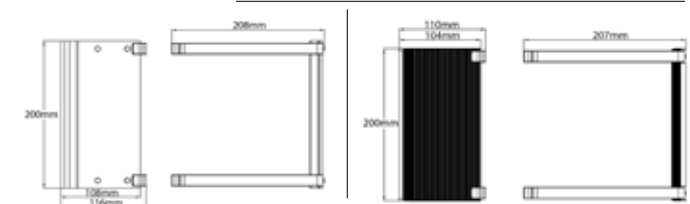
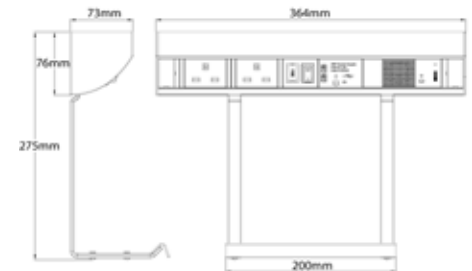

Sensio products for every bedroom...

- 86** Rechargeable Battery Wardrobe Lighting
- 94** Low Voltage Wardrobe Lighting
- 98** LED Reading Lights
- 112** Drivers

Also consider...

- 14** LED Spot Lighting
- 42** Drawer Lighting
- 54** Flexible Strip Lighting
- 63** Aluminium Profiles
- 74** Wireless Charging
- 76** SensioPod
- 101** Lighting Control





The importance of bedroom lighting

A great lighting scheme can really make a difference to the functionality & atmosphere of the bedroom. Consider wardrobe lights and reading lights for practicality, and flexible strip lighting to create a relaxing atmosphere. Here's an example of how Sensio LED lighting can truly transform the bedroom.



Before **sensio** lighting

innovate.
create.
illuminate.™



After **sensio**® lighting



Rechargeable Battery Wardrobe Lighting >



Innovative Lithium-ion Battery

Use our Rechargeable Lithium-ion battery solutions in wardrobes or kitchen cabinets. Simple, yet extremely effective.

Advantages of our rechargeable battery lighting range

- **No wiring.** No electrical installation required. Can be retrofitted by anyone.
- **Simple to maintain.** The battery within these fittings is to be recharged as required using a pluggable USB charger.
- **Low running cost.** The battery only needs to be recharged 2-3 times a year (based on an average usage figure).
- **Flexibility.** The fitting can be placed in any position in the cabinet without having to worry about visible cables or drilling holes for the cable.

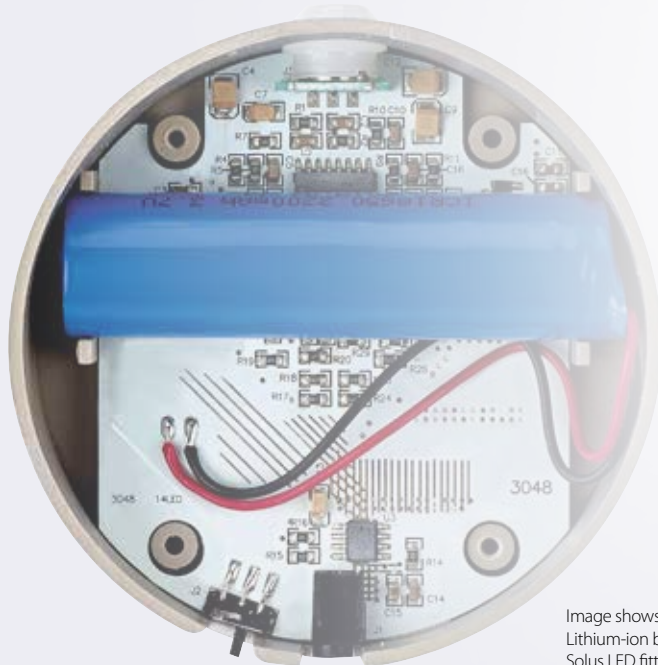

Image shows the rechargeable Lithium-ion battery inside the Solus LED fitting.

Image shows the Solus on charge using the USB outlet on the charger.



About the battery

- Lithium-ion battery
- Rechargeable
- High energy density
- Slow loss of charge when not in use
- Self-discharge rate of approximately 5-10% per month
- The lifespan of all products in this range is 30,000 hours
- Pluggable charger with 5m USB charging cable
- Charging time is 3-5.5 hours on average
- The running time of battery operated products between charging is 5-6.5 months on average (based on 2 minutes usage per day)

Alto LED Wardrobe Rail Light



'speed up your morning routine'

- > Aluminium wardrobe rail light with anti-slip design.
- > Features an integrated PIR sensor which automatically switches the light on when the wardrobe door is opened.
- > The PIR will remain on for 30 seconds and then automatically switch off if no movement is detected to ensure there is no power wastage.
- > The rail is available in 4 lengths, all of which can be cut down if required. (The cut lengths stated below are the maximum lengths which can be cut from the left side of the unit)
- > No electrical installation required. Contains a Lithium-ion rechargeable battery.
- > The run time of the product is 6.5 months based on 2.5 minutes of use per day. The charging time is 5.5 hours on average.
- > The LED's in this fitting have a lifespan of 30,000 hours.
- > Recharge the unit using the 03.2005.0800 pluggable USB charger.
- > The maximum weight load of the rail is 20kg.



Code	Wattage	Length	LED Qty	LED Colour	Cut Length	Lumens	RRP
03.2001.0610	0.6W	562mm	11pcs	Cool White (4500K)	100mm	55 lm	£65.64
03.2002.0610	0.8W	762mm	15pcs	Cool White (4500K)	300mm	75 lm	£80.28
03.2003.0610	1W	962mm	19pcs	Cool White (4500K)	500mm	95 lm	£88.92
03.2004.0610	1.2W	1162mm	23pcs	Cool White (4500K)	600mm	115 lm	£93.60

Accessories		
03.2005.0800	Pluggable USB Charger with 5m USB charging cable	£9.60
03.2006.0603	Top mounting brackets with centre support	£8.28



Side mounting bracket set included



Top mounting brackets with additional centre support (sold separately)

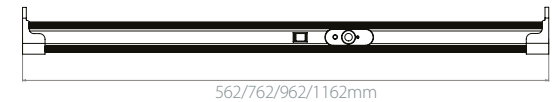

Incline LED Wardrobe Strip Light



'light angled to prevent glare'

- > Features an integrated PIR sensor which automatically switches the light on when the wardrobe door is opened.
- > The PIR will remain on for 30 seconds and then automatically switch off to ensure there is no power wastage.
- > This fitting is available in 3 standard lengths, however can be cut down if required.
- > No electrical installation required. Contains a Lithium-ion rechargeable battery.
- > The run time of the product is 6.5 months based on 2.5 minutes of use per day. The charging time is 4.5 hours on average.
- > The LED's in this fitting have a lifespan of 30,000 hours.
- > Recharge the unit using the 03.2005.0800 pluggable USB charger.
- > Cool white LED for optimum light output.
- > Suitable for use in a wardrobe or kitchen cabinet.



Code	Length	Wattage	LED Qty	LED Colour	Cut Length	Lumens	RRP
SE20242C0	350mm	0.4W	6pcs	Cool White (6000K)	N/A	27 lm	£80.04
SE20252C0	550mm	0.6W	10pcs	Cool White (6000K)	100mm*	48 lm	£82.20
SE20272C0	850mm	0.9W	16pcs	Cool White (6000K)	400mm*	80 lm	£98.76

Accessories		
03.2005.0800	Pluggable USB Charger with 5m USB charging cable	£9.60

* Maximum cut length. An equal amount has to be cut from each end of the fitting.



Pluggable USB Charger
(purchase separately)
03.2005.0800

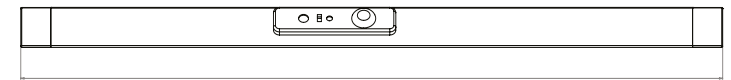

350/550/750/850/950mm

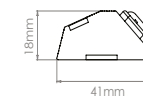

Solus

Angled LED Wardrobe Spot Light

FINISH:
aluminium

LED COLOUR:
cool

RECHARGEABLE:

RETROFIT

LAMP LIFE:
30,000
hours

BEAM ANGLE:
120°

'so simple to install and maintain'

- > The versatile Solus angled round light is specifically designed for illuminating the interior of wardrobes and cabinets and is ideal for retro-fitting.
- > Contains a rechargeable Lithium-ion battery. No electrical installation required.
- > The product is cable free for ease of installation.
- > Rechargeable via a pluggable USB charger.
- > Angled surface light to reduce glare.
- > Features an integrated PIR sensor which automatically switches the light on/off when the wardrobe or cabinet door is opened/closed.
- > The detection range of the PIR is 2m allowing the fitting can be positioned as required inside the wardrobe/cabinet.
- > The battery life of the product is 5 months based on 2 minutes of use per day. The charging time is 3 hours on average.
- > The product also has an override on/off switch.



Code	Wattage	LED Qty	LED Colour	Qty	Lumens	RRP
SE20061C0	0.7W	14pcs	Cool White (4500K)	1	52 lm	£42.48

Accessories		
SE2007000	Pluggable USB Charger with 5m cable	£11.76

Surface mounted with integrated PIR



Charging point & on/off switch



Rechargeable battery via USB Charger.

Charge using the plug provided or via the USB cable (using a laptop for example).

Red indicator light shows that the unit is charging.

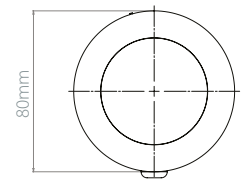

Mounting bracket included for installation

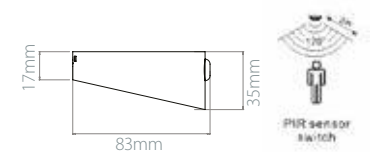

Mimas LED Wardrobe Light



'lighting just where you need it'

- > The versatile Mimas rectangular light is specifically designed for illuminating the interior of wardrobes and cabinets and is ideal for retro-fitting.
- > Contains a rechargeable Lithium-ion battery. No electrical installation required.
- > The product is cable free for ease of installation.
- > Rechargeable via a pluggable USB charger.
- > Features an integrated PIR sensor which automatically switches the light on/off when the bathroom cabinet door is opened/closed.
- > The detection range of the PIR is 2m, meaning the fitting can be positioned as required inside the wardrobe/cabinet.
- > The battery life of the product is 5 months based on 2 minutes of use per day. The charging time is 3 hours on average.
- > The product also has an override on/off switch.



Code	Wattage	LED Qty	LED Colour	Qty	Lumens	RRP
SE20051C0	0.7W	14pcs	Cool White (4500K)	1	52 lm	£51.00

Accessories						
SE2007000	Pluggable USB Charger with 5m cable					£11.76



Charging point & on/off switch



Pluggable USB Charger
(purchase separately)
SE2007000

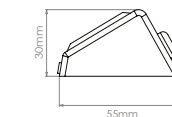
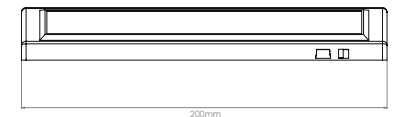

Mounting bracket included for installation

Prisma Tiltable LED Wardrobe Light



'angle the light as you need it'

- > This discreet adjustable light is perfect for illuminating the interior of wardrobes and cabinets and is ideal for retrofitting.
- > The tiltable LED centre allows you to angle the light as required.
- > Contains a rechargeable Lithium-ion battery. No electrical installation required.
- > This product is cable free for ease of installation.
- > Rechargeable via pluggable USB charger.
- > Features an integrated PIR sensor which automatically switches the light on/off when the cabinet door is opened/closed - this feature has been improved for enhanced efficiency to include an option where the PIR sensor will only activate when the surrounding area is dark.
- > The battery life of the product is 5 months based on 2 minutes of use per day. The charging time is 3 hours on average.
- > This is the most discreet rechargeable solution - it has the slimmest profile.



Code	Wattage	LED Qty	LED Colour	Qty	Lumens	RRP
SE20230W0.1	0.5W	8pcs	Cool White (4500K)	1	57 lm	£35.88

Accessories		
SE2007000	Pluggable USB Charger with 5m cable	£11.76

Switch to Day/Night - the PIR sensor will work whatever the surrounding light level is.
Switch to On - the PIR sensor will only work when the surround lighting is dark.
Switch to Off - will turn off all the functions.

Surface mounted with integrated PIR



Charging point & On, Day/Night and Off switch.



Rechargeable battery via USB Charger.
Charge using the plug provided or via the USB cable (using a laptop for example).



Pluggable USB Charger (purchase separately) SE2007000

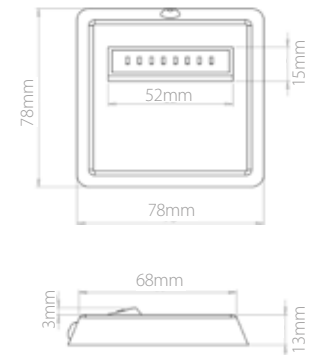

Mounting bracket included for installation

Rechargeable Wardrobe Lighting >

Orion LED Under Bed Light



'illuminates the floor as motion is detected'

- > The versatile Orion light is perfect for fitting inside cabinets, wardrobes or on the underside of the bed. Ideal for retro-fitting.
- > Contains a rechargeable Lithium-ion battery. No electrical installation required.
- > The product is cable free for ease of installation.
- > Rechargeable via a pluggable USB charger.
- > Simple to install, the Orion has an adjustable hinge which is simply to be screwed to the underside of the bed.
- > The detection range of the PIR is 2m, meaning that the fitting projects a beam of light across the floor when mounted to the underside of a bed, should you need to get up in the middle of the night.
- > The battery life of the product is 5 months based on 2 minutes of use per day. The charging time is 3 hours on average.
- > The product also has an override on/off switch.



Code	Wattage	LED Qty	LED Colour	Qty	Lumens	RRP
SE20292W0	0.4W	6pcs	Cool White (4500K)	1	32 lm	£44.16

Accessories						
SE2007000	Pluggable USB Charger with 5m cable					£11.76

Integrated PIR & Rechargeable Battery Pack



Pluggable USB Charger (purchase separately) SE2007000



Rechargeable Battery Pack

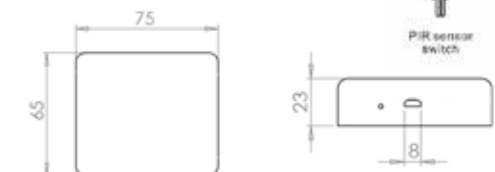



Low Voltage Wardrobe Lighting >



Elara LED Wardrobe Rail Light

FINISH:

aluminium

LED COLOUR:

cool

LAMP LIFE:

30,000
hours

DRIVER:

12V

CABLE LENGTH:

2 metres



BEAM ANGLE:

100°

'lighting truly integrated into your wardrobe'

- > Aluminium wardrobe rail light.
- > Features an integrated PIR sensor which automatically switches the light on when the wardrobe door is opened.
- > The PIR will remain on for 30 seconds and then automatically switch off if no movement is detected to ensure there is no power wastage.
- > The rail is available in 3 standard lengths, however can be cut down from the left side if required. Ensure you leave 100mm from the left side of the sensor and the remaining length can then be cut as required.
- > Contains a soft rubber strip to prevent items from slipping on the rail.
- > The maximum weight load of the rail is 20kg.
- > Side mounting brackets provided.
- > The advantages of the Elara over the Alto are; the higher light output and no maintenance is required (no requirement to recharge).



Code	Wattage	Length	LED Qty	LED Colour	Cut Length	Lumens	Driver	RRP
SE20021C0	2.6W	762mm	36pcs	Cool White (4500K)	300mm*	132 lm		£52.80
SE20031C0	3.2W	962mm	45pcs	Cool White (4500K)	300mm*	152 lm		£62.40
SE20041C0	3.9W	1162mm	54pcs	Cool White (4500K)	400mm*	170 lm		£67.80

* Cut length refers to the amount which can be cut from each fitting. Keep 100mm from the left side of the PIR sensor switch, the remaining length on the left side can be cut.

Accessories

03.2006.0603	Top Mounting Brackets with Centre Support	£8.28
SE9009	2.5m Extension Cable	£2.64

Drivers

(for more drivers see page 112)

SE40625	6W LED Driver with 4 Port JB4 Distributor	£16.68
---------	---	--------

Built-in PIR



Side mounting bracket set included



Top mounting brackets with additional centre support sold separately

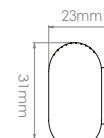
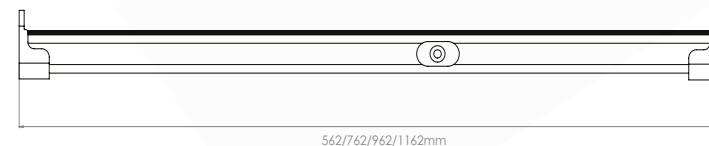
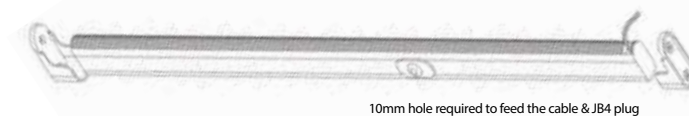

Operio Mini LED Wardrobe Light

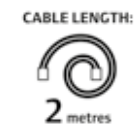

'small and discreet, side or top mount'

- > Surface mounted product for simple installation.
- > Fit at the top of a wardrobe/cabinet or at the side as pictured to throw light across the width of the wardrobe.
- > Compact design for a discreet lighting solution.
- > Contains an integrated PIR sensor switch, so the light will switch on when the wardrobe/cabinet door is opened.
- > The PIR has a detection range of 2m so the fitting can be positioned in the wardrobe as required.
- > The LED's in this fitting are concealed.
- > The curved aspect of the fitting means the light is dispersed evenly and is directed back into the wardrobe/cabinet as required.
- > High light output, low energy consumption.
- > Each 120mm fitting runs at only 1.2W.



Code	Wattage	LED Qty	LED Colour	Qty	Lumens	Driver	RRP
SE20081C0	1.2W	3pcs	Cool White (4500K)	1	28 lm		£32.28
SE20081C2	2.4W	3pcs (PF)	Cool White (4500K)	2	28 lm (PF)	included	£81.60

PF - per fitting

Pack includes 2 fittings and one 6W driver.

Accessories		
SE9009	2.5m Extension Cable	£2.64

Drivers (for more drivers see page 112)		
SE40625	6W LED Driver with 4 Port JB4 Distributor	£16.68

Integrated PIR



Concealed LED's

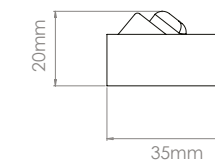
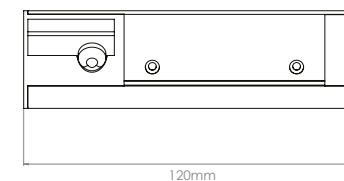
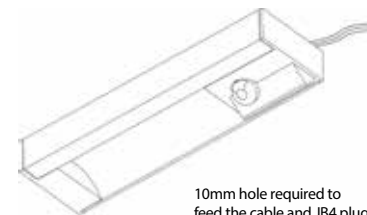

Operio LED Wardrobe Light

FINISH:
aluminium

LED COLOUR:
cool

LAMP LIFE:
30,000
hours

DRIVER:
12V

CABLE LENGTH:
2 metres

BEAM ANGLE:
45°

'two sensors for left & right doors'

- > Contains 2 integrated PIR sensor switches, so the light will switch on no matter which side of the wardrobe is opened.
- > The PIR has a detection range of 2m so the fitting can be placed in the centre of the wardrobe and will still detect the door opening.
- > Surface mounted product for simple installation.
- > The LED's in this fitting are concealed.
- > The curved aspect of the fitting means the light is dispersed evenly and is directed back into the wardrobe/cabinet as required.
- > The LED's in this fitting have a lifespan of 30,000 hours.
- > High light output, low energy consumption.
- > Each 400mm fitting runs at only 2.2W.



Code	Wattage	LED Qty	LED Colour	Finish	Lumens	Driver	RRP
SE20111C0	2.2W	30pcs	Cool White (4500K)	Aluminium	100 lm		£52.80

Accessories							
SE9009	2.5m Extension Cable						£2.64

Drivers (for more drivers see page 112)							
SE40625	6W LED Driver with 4 Port JB4 Distributor						£16.68

Surface mounted with 2 x PIR switches



Concealed LED's

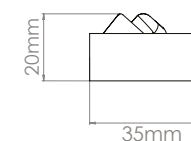
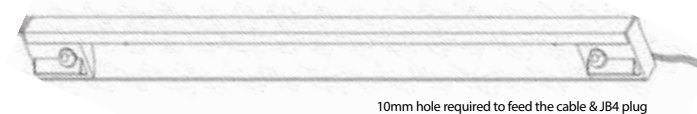



LED Reading Lights >



Opus LED Reading Light

FINISH:



aluminium

LED COLOUR:



cool

LAMP LIFE:



hours

CABLE LENGTH:



1.5 metres

BEAM ANGLE:



10°

'one high power LED for the brightest output'

- > This fitting contains one high power LED, the brightest of the Sensio reading light range.
- > Built-in driver for ultimate ease of installation.
- > The 350mm flexible arm makes it simple to adjust the position of the light.
- > The fitting has a small push switch on the top of the light head, making it simple to switch the light on/off as required.
- > Low energy consumption. Each fitting runs at only 1.7W.
- > The 10 degree beam angle means the light source is very direct.
- > The small size of the light head makes for a discreet but powerful task light.
- > Quick and simple to install. Either hard-wire or connect to a 3-pin plug top and connect directly to the mains supply with no need for an external driver.



Code	Wattage	LED Qty	LED Colour	Qty per pack	Lumens	RRP
SE20121C0	1.7W	1pc	Cool White (5000K)	1 light	66 lm	£51.12
SE20121C2	1.7W (PF)	1pc (PF)	Cool White (5000K)	2 lights	66 lm (PF)	£102.48

PF - Per Fitting

On/off switch integrated



Built-in driver

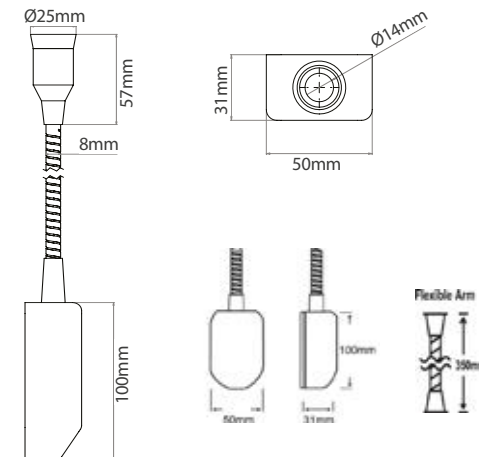

Flecto LED Reading Light

FINISH:



aluminium

LED COLOUR:



cool

LAMP LIFE:



hours

CABLE LENGTH:



1.5 metres

BEAM ANGLE:



140°

'in-built driver for ease of installation'

- > The long head of the lamp and 140 degree beam angle allows for greater dispersion of the light.
- > Built-in driver for ultimate ease of installation.
- > The 350mm flexible arm makes it simple to adjust the position of the light.
- > The fitting has a small push switch on the end of the light head, making it simple to switch the light on/off as required.
- > Extremely low energy consumption. Each fitting runs at only 1.6W.
- > Quick and simple to install. Either hard-wire or connect to a 3-pin plug top and connect directly to the mains supply with no need for an external driver.



Code	Wattage	LED Qty	LED Colour	Qty per pack	Lumens	RRP
SE20131C0	1.6W	9pcs	Cool White (5000K)	1 light	32 lm	£45.48
SE20131C2	1.6W (PF)	9pcs (PF)	Cool White (5000K)	2 lights	32 lm (PF)	£91.08

PF - Per Fitting

Built-in driver



On/off switch integrated on the end of the fitting

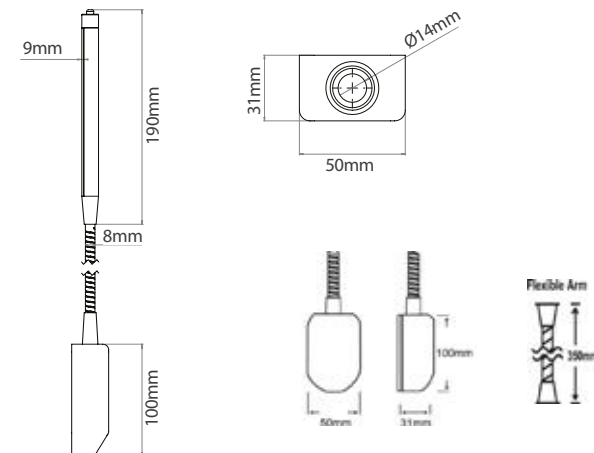

Lighting Control >



Sensio Multi-Light Mobile Lighting Control



*Award Winning
Winner in the 'Innovation in Wifi
and App Technology' category
for the Designer Kitchen &
Bathroom Awards 2016.*



- Multiple light type control (single colour, RGB, DuoFlex)
- Simple installation, now or later (can be retrofit)

- Easy to use FREE iOS App
- No more remotes, control all lighting from one App

Sensio Multi-Light App Bluetooth Receivers

'control Sensio lighting from your mobile device'

> Control any Sensio lighting product which requires a 12/24V Sensio driver from an Apple mobile and tablet device.

> How it works:

- Simply plug the relevant type of receiver for your lighting (single colour, RGB or Duo Colour) into your drivers. A receiver* is required for each driver which is connected to lighting you'd like to control from the App.
- Download 'Sensio Multi Light' from the Apple App store (free to download).
- Switch all lighting to be controlled via the App on.
- Follow the Sensio instructions to simply configure your preferred settings.

> Features:

- On/off switching of connected lights
- Single product selection - choose to control each type/area of lighting individually
- Group lighting - group all/some of your lighting to be controlled together
- Your settings - set-up lighting area's and control each area separately
- Music - colour changing lighting will change to the sound of your music



Code	Product Description	Max. Wattage	Driver	RRP
SE792990	Bluetooth Receiver - Single Colour LED	36W () or 72W ()		£29.76
SE793990	Bluetooth Receiver - RGB LED	72W ()		£33.24
SE794990	Bluetooth Receiver - Duo Colour LED	72W ()		£31.92

Driver(s) to be purchased separately

Detection range of the receivers is ≤10m

*The App can pair with up to 4 receivers

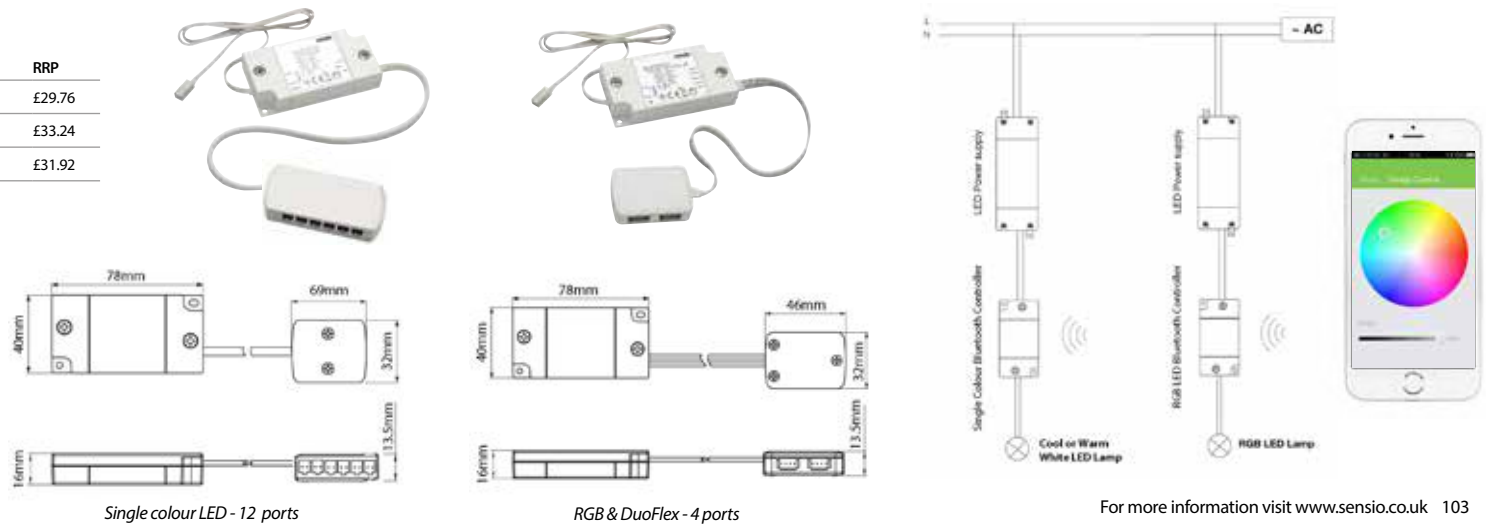

LED Dimming Remote Control

'dimming and switching for all areas of lighting'

- > Create or choose the lighting level that is perfect for you at the touch of a button.
- > Multiple functions of the dimmer:
 - Dim to the lowest light level - press the left hand button once.
 - Set to full brightness - press the right hand button once.
 - Select the desired light level by turning the dial.
 - On/off switching - press the middle button.
- > Memory function of the performance before last switched off.
- > There is no limit on the number of receivers which can be controlled via one remote control. All receivers within a 15m range of the remote can be controlled via a single remote.
- > One receiver is required for each driver (connected to the lights you wish to control).
- > Suitable for single colour LED lighting only.



Multiple receivers can be run from 1 dimming remote control

Code	Product Description	Max. Wattage	Driver	RRP
SE790050	LED Dimming Receiver	30W () or 60W ()		£37.13
SE793090	LED Dimming Remote Control	n/a		£28.82



LED Dimming Remote Control

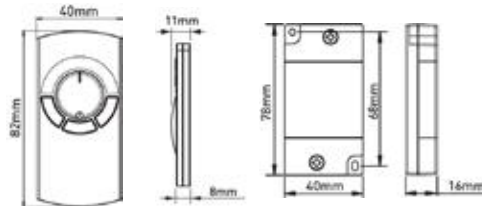

Driver(s) to be purchased separately

Cannon Cabinet/Swipe Sensor Switch

FINISH:
aluminium

CABLE LENGTH:
2.5 metres

'activate and dim lights with motion'

- > Can be used with 12V & 24V products (without an integrated sensor) and has been upgraded to accommodate higher wattages so that more light fittings can be used with the sensor.
- > Three functions of this infra-red sensor:
 - Mount inside a cabinet – open door to activate light.
 - Mount under cabinet – lights are activated when a hand passes before the sensor for less than one second.
 - Mount under cabinet - new dimming function where lights will dim down/up when a hand is held under the sensor for longer than one second.
- > 5cm detection range, so unwanted detection is not a problem.
- > Plug and play solution, simply connect the sensor to the driver, the lights to the sensor distribution block and hide the cable.
- > Can be surface or recess mounted into a pelmet
- > The product is preset to the Monostable function.
- > 1 x JB4 Distribution Block supplied with each sensor.

Now with added dimming function

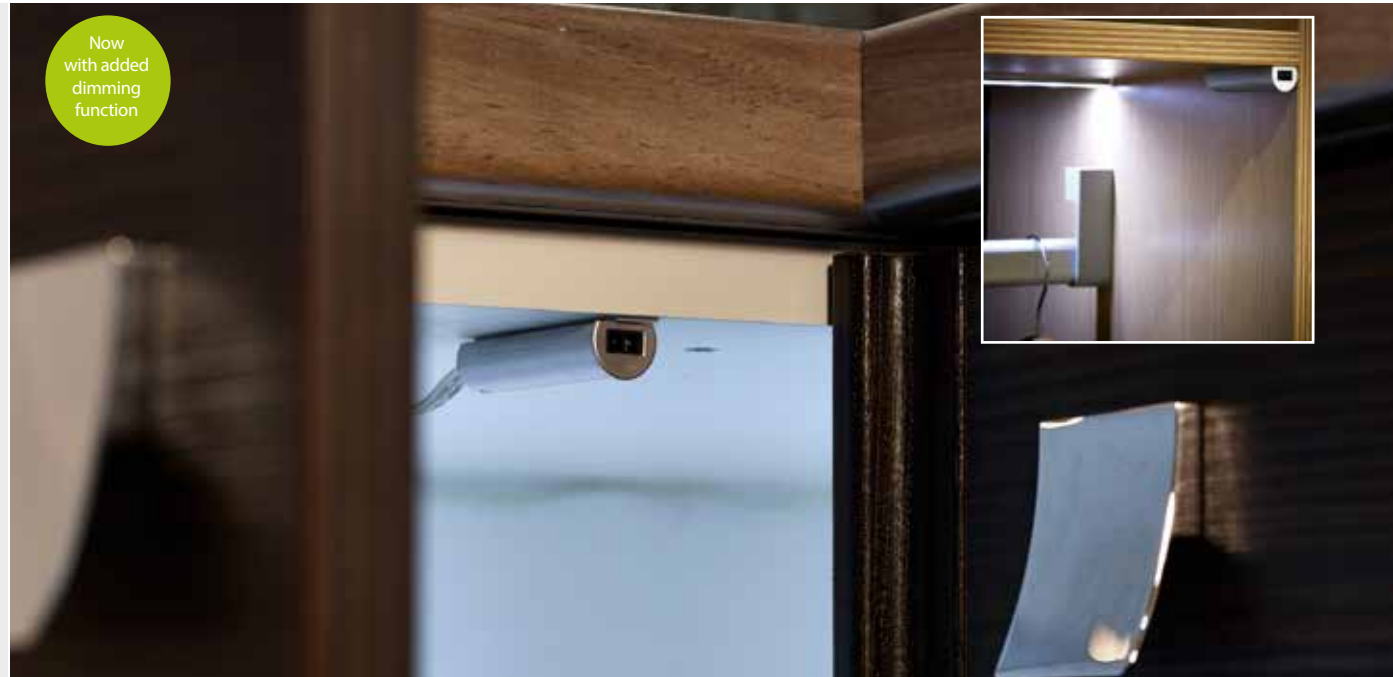

Code	Max. Wattage	Cut out:	Detection range	Driver	RRP
SE40516.1	24W (orange) or 48W (green)	14mm	5cm	Orange Green	£20.16

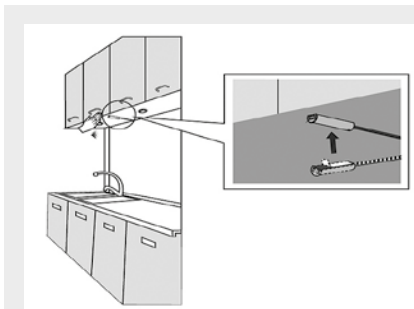

Bistable function

For under cabinet mounting.

1. Move your hand over the sensor to switch the lights on and then move your hand over the sensor again to switch the lights off.
2. To dim the connected lights, place your hand within 5cm of the sensor for longer than one second, the lamp will dim up/down until your hand is removed from the detection range.

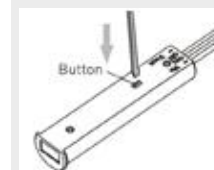

Function set:

1. To set the function, first connect to the power supply.
2. Pressing the button switches the function from one to the other.

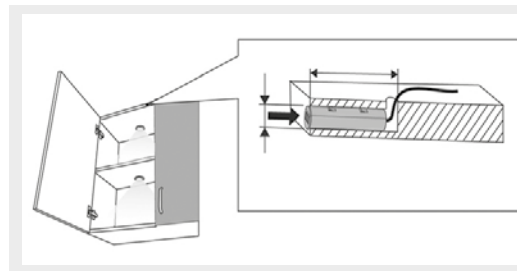

Monostable function

For internal cabinet mounting.

1. Open the cabinet door to switch the connected lights on.
2. Close the cabinet door to switch the connected lights off.

Connect to driver

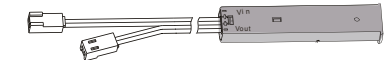

Connect to distribution block supplied.
Connect up to 5 lights to this block

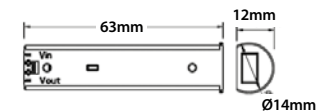

Moda LED Dimming Sensor Switch

FINISH:
aluminium

CABLE LENGTH:
1.5 metres

'3 functions including dimming'

- > Multi-functional product.
- > The SE40520 has 3 functions; use as a dimmer, external on/off switch or in-cabinet on/off switch for 12V & 24V LED products.
- > Attractive product, perfect for contemporary kitchens.
- > Use with any 12V or 24V Sensio product (without an integrated sensor).
- > Aluminium effect finish to match many of our best selling products.
- > Plug and play, and no additional wiring is required by the electrician.
- > IR Sensor with a 5cm detection range (swipe on/off function).
- > Memory function of the last setting before the lighting was switched off.
- > 1.5m cable from the sensor to the JB4 plug and 1.5m from the sensor to the 6 port JB4 distribution block.



Code	Max. Wattage	Detection range	Driver	RRP
SE40520	15W () or 30W ()	5cm		£17.76

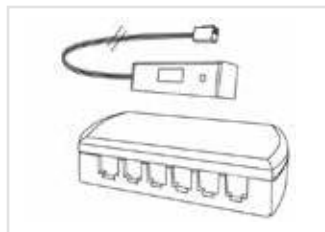

Extremely simple connection system. The JB4 plug from the sensor connects to the LED driver and the lights connect to the distribution block on the sensor.

Operation:
The SE40520 sensor has three functions.

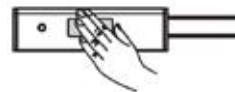

Under cabinet - The lights are activated by a hand swipe across the sensor and deactivated the same way.

In Cabinet - The lights are activated by the opening of a cabinet door and deactivated once the door closes.

Dimming - Hold your hand in front of the sensor to dim the lights. The lights will dim/brighten in increments of 10%. Remove your hand once the desired brightness level is achieved.

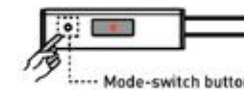

Once a power source is connected a red indicator light within the sensor will illuminate when the lights are off.

This fitting can be used under a cabinet or inside a cabinet. To switch the function of the sensor press the mode-switch button.

A maximum of 11 products can be connected to the Moda (unless daisy chained).

SE40520 - Dimming Sensor Switch

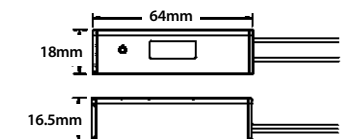



250W Infra-red Sensor Switch

'activate your lights with motion'

- > Maximum detection range: 5-10cm, to ensure the sensor is not activated when not required. Swipe hand past the sensor to activate lights.
- > Can be used with; 12V, 24V or 240V fittings.
- > Suitable to use with the majority of Sensio fittings.
- > The motion sensor detects body heat motion and automatically switches the lights on or off.
- > High wattage of 250W means the sensor will run a large number fittings.
- > Rated input voltage: AC100-240V.
- > Discreet fitting, sits almost flush to the furniture with a cut-out of only 13mm required.



Code	Max. Wattage	Cut out:	Cable length:	Detection range	Driver	RRP
SE40517	250W	13mm	2m	5-10cm	 or 240V	£27.96

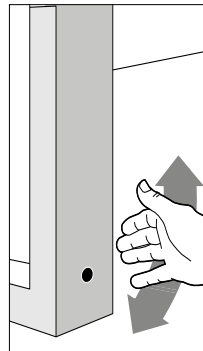

Recess into the side panel of a kitchen cabinet. A hand swipe will switch all connected lighting on/off.

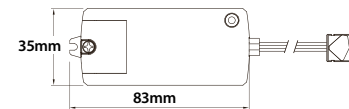
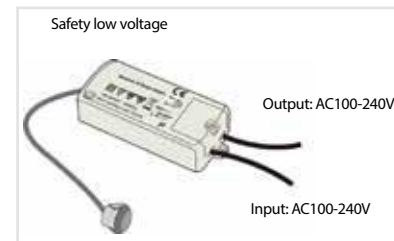

In-Cabinet PIR Sensor Switch

FINISH:



aluminium

CABLE LENGTH:



1.5 metres

'discreet in-cabinet motion sensor switch'

- > Suitable to be used with 12V, 24V or 240V products without an integrated sensor.
- > Works as an on/off switch for lighting installed inside cabinets or wardrobes. Mount in a side panel or back panel of an internal unit.
- > Small and discreet product.
- > This sensor does not have any JB4 connectors.
- > A dial on the front of the sensor unit allows you to select the time delay on the sensor (from 10 seconds to 3 minutes).
- > 80° detection angle.
- > 0.5m - 2.5m detection range.



Code	Max. Wattage	Detection range	Driver	RRP
SE40515	250W	0.5-2.5m	 or 240V	£29.64

SE40515



Top View

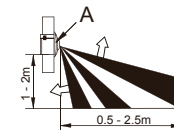

Side View

Part A should be positioned parallel to the floor.

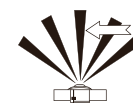
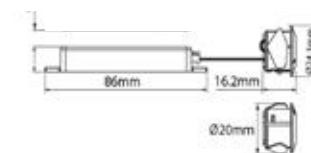

Good Sensitivity

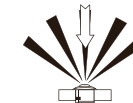

Poor Sensitivity

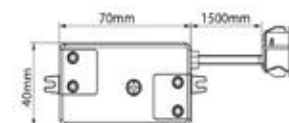



250W In-Cabinet IR Sensor Switch

'door sensor switch to activate your lights'

- > Detection range of 5-10cm. Recess into internal shelves in wall units or wardrobes. When the door is opened all connected lighting will be switched on and switched off when the door closes.
- > Can be used with; 12V, 24V or 240V fittings which do not have an integrated switch or sensor.
- > High wattage of 250W means the sensor will run a large number fittings.
- > The light(s) will switch on once the door opens as the sensor detects that the door is no longer blocking its path and they'll be switched off once the door is closed.
- > Very discreet switching option, especially in darker furniture.
- > Can be used in kitchens or bedrooms.



Code	Max. Wattage	Cut out:	Cable Length	Detection range	Driver	RRP
SE40518	250W	13mm	2m	5-10cm	or 240V	£27.96

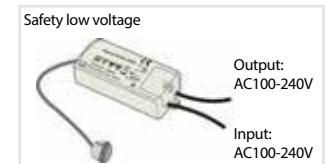
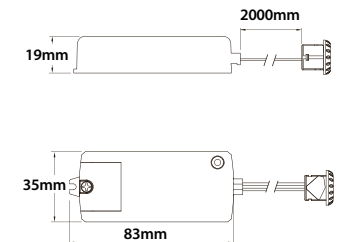
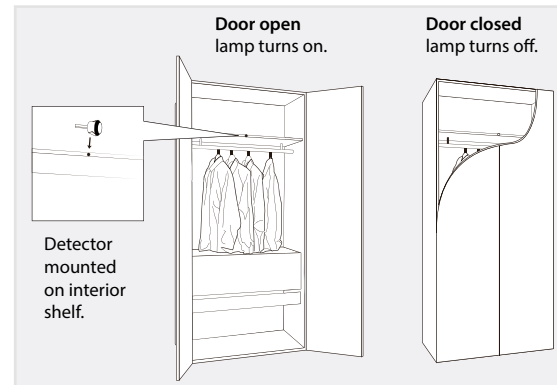

Cable connect system

Changing LED light fittings couldn't be simpler!
The Sensio cable connect system enables light fittings to be easily changed without the need to access or remove existing cabling.

Save time and money with the Sensio cable connect system



Features & benefits:

- > No need for a fitter if you wish to change or replace an LED fitting as the cabling does not need to be accessed or pulled through from behind the cabinet.
- > Lamps can be changed by anyone.

- > Available on HD LED under cabinet spot light products.
- > Each fitting has a 2.5m cable. The lamp has a 35mm cable with JB4 plug which connects to the main run of cable.



Connecting by colour

Sensio's colour coding system makes ordering everything required for your lighting design that little bit simpler.

To simplify the process of selecting the appropriate driver for your lighting requirements, Sensio use a simple colour coding system. The cable on the light fitting, the distributor block on the driver and the outer packaging for each product all carry a colour-coded label.

- > All **components** are **colour coded**.
- > The **packaging** is **colour coded**.
- > The **cable** on the product (above the connection plug) is **colour coded**, this ensures that there is no danger of connecting a product to a driver of the incorrect voltage.
- > The **wattage of the driver is also indicated on the block** so when connecting fittings you can be sure not to exceed the wattage allowance of the driver.

All components and even the packaging is colour coded.



All drivers featured in this brochure are coded with a small coloured square. Simply refer to the product table opposite to find the colour that is correct for your lights.



Drivers

How to select the right driver for your lights:

1. All **drivers** in this brochure are **colour coded**. Refer to the product table to find the colour that is correct for your lights.
2. Each driver can run a number of lights. Simply **divide the wattage of the driver by the wattage of a single light** and this will tell you exactly how many lights can be run by the driver.

Example:
15W driver with 3W lights
 $15 \div 3 = 5$ lights

3. **Sensio drivers are available in various wattages** e.g. 15W and 30W. Simply work out the best option dependent on the number of lights you have.

Note: Drivers have a limited number of ports where lights are connected. A driver with 12 ports is therefore limited to a maximum of 12 lights. See the table for the number of ports.

Code	Description	Colour Coding	Dimensions (LxWxD)	RRP
SE40625	6W Driver with 4 Port JB4 Distributor	■	58x34x20mm	£16.68
SE40525	15W Driver with 6 Port JB4 Distributor	■	120x45x20mm	£22.68
SE40526	30W Driver with 12 Port JB4 Distributor	■	150x40x31mm	£39.84
SE40553	6W Driver with 4 Port JB4 Distributor	■	52x34x20mm	£17.40
SE40555	15W Driver with 6 Port JB4 Distributor	■	120x45x20mm	£23.04
SE40556	30W Driver with 12 Port JB4 Distributor	■	155x42x32mm	£37.68
SE40557.1	60W Driver with 12 Port JB4 Distributor	■	185x60x31mm	£59.40



12V & 24V driver examples

Product Index

Under Cabinet Spot Lighting

Product Code	Product Description	Page Number
SE10138CW	Calida LED Flat Disc Light - Cool White	30
SE10138WW	Calida LED Flat Disc Light - Warm White	30
SE10156CW	GX53 Lamp - Cool White	31, 32
SE10156WW	GX53 Lamp - Warm White	31, 32
SE10166C0	SLS Lara Surface/Recessed Light - Cool White	21
SE10166W0	SLS Lara Surface/Recessed Light - Warm White	21
SE11146SS	GX53 Circa LED Recessed/Surface Light	31
SE11147SS	GX53 Trigon LED Triangle Light	32
SE21000C0	SLS Bermuda LED Triangle Light - Cool White	23
SE21000W0	SLS Bermuda LED Triangle Light - Warm White	23
SE21006C0	Alti Square Prismatic LED Light - Cool White	16
SE21006W0	Alti Square Prismatic LED Light - Warm White	16
SE21090C0	SensioSound LED Bluetooth Speaker Light - Cool White	19
SE21090W0	SensioSound LED Bluetooth Speaker Light - Warm White	19
SE21092C0	SLS Quadra LED Under/Over Cabinet Light - Cool White	20
SE21092W0	SLS Quadra LED Under/Over Cabinet Light - Warm White	20
SE21100C0	SLS Hype LED Recess/Surface Light - Cool White	22
SE21100W0	SLS Hype LED Recess/Surface Light - Warm White	22
SE21190C0	Nico 240V LED Surface/Recessed Light - Cool White	24
SE21190W0	Nico 240V LED Surface/Recessed Light - Warm White	24
SE21192C0	SLS Quadra LED Under/Over Cabinet Light with Sensor - Cool White	20
SE21192W0	SLS Quadra LED Under/Over Cabinet Light with Sensor - Warm White	20
SE21290C0	Venus COB LED Recess/Surface Light - Cool White	17
SE21290W0	Venus COB LED Recess/Surface Light - Warm White	17
SE21390C0	Titon COB LED Triangle Light - Cool White	18
SE21390W0	Titon COB LED Triangle Light - Warm White	18
SE22006C0	PAD2 Prismatic LED Light - Cool White	15
SE22006W0	PAD2 Prismatic LED Light - Warm White	15
SE9001HDCW	Novus HD LED Triangle Light - Cool White	26
SE9001HDWW	Novus HD LED Triangle Light - Warm White	26
SE9001HDSSCW	Bermuda HD LED Triangle Light - Cool White	28
SE9001HDSSWW	Bermuda HD LED Triangle Light - Warm White	28

Under Cabinet Spot Lighting

Product Code	Product Description	Page Number
SE9005HDSSCW	Hype HD LED Surface Light - Cool White	27
SE9005HDSSWW	Hype HD LED Surface Light - Warm White	27
SE9007HDCW	Ora LED Square Surface Light - Cool White	29
SE9007HDWW	Ora LED Square Surface Light - Warm White	29
SE9008HDCW	Orbit Tilttable LED Light - Cool White	25
SE9008HDWW	Orbit Tilttable LED Light - Warm White	25

Under Cabinet Strip Lighting

Product Code	Product Description	Page Number
SE10173W0	Connex 240V SLS LED Strip Light	35
SE12250 - 250mm	Albus LED Strip Light	36
SE9071HDCW	Arrow Slim Profile SLS LED Strip Light - Cool White	34
SE9071HDWW	Arrow Slim Profile SLS LED Strip Light - Warm White	34

In Cabinet Lighting

Product Code	Product Description	Page Number
SE23092C0	SLS Quadra LED In Cabinet Light - Cool White	38
SE23092W0	SLS Quadra LED In Cabinet Light - Warm White	38

Shelf Lighting

Product Code	Product Description	Page Number
SE30156W0	Florence IP44 LED Glass Shelf Light	41
SE9063HDCW	Edge SLS LED Glass Clip Light - Cool White	40
SE9063HDWW	Edge SLS LED Glass Clip Light - Warm White	40

Drawer Lighting

Product Code	Product Description	Page Number
SE7300HDCW	Verso LED Drawer Light	43
SE9030HD	Vista LED Battery Drawer Light	44

Product Index

Over Cabinet Lighting

Product Code	Product Description	Page Number
SE21092C0	SLS Quadra LED Under/Over Cabinet Light - Cool White	46
SE21092W0	SLS Quadra LED Under/Over Cabinet Light - Warm White	46
SE9015HDCW	Asta Over Cabinet Light - Cool White	47
SE9015HDWW	Asta Over Cabinet Light - Warm White	47

Plinth Lighting

Product Code	Product Description	Page Number
SE15090C0	Luce SLS LED Square Plinth Light - Cool White	50
SE15090W0	Luce SLS LED Square Plinth Light - Warm White	50
SE15091C0	Specto LED Round Plinth Light - Cool White	51
SE15091W0	Specto LED Round Plinth Light - Warm White	51
SE15094C0	Puro LED Round Plinth Light - Cool White	52
SE15094W0	Puro LED Round Plinth Light - Warm White	52
SE35000C6	Nimbus LED Plinth Light Kit	53

Flexible Strip Lighting

Product Code	Product Description	Page Number
SE10005R0	RGB Colour Changing Flexible Strip - 330mm	61
SE10011D0	DuoFlex Flexible Strip - 1000mm	59
SE1003000	DuoFlex Remote Control	60
SE1004100	DuoFlex Receiver	60
SE10055C0	Primo 5m Clip LED Flexible Strip	58
SE10310CW.1	Viva LED Flexible Strip 333mm - Cool White	57
SE10310WW.1	Viva LED Flexible Strip 333mm - Warm White	57
SE20015C0.1	Compact Multi-point LED Flexible Strip 1000mm - Cool White	56
SE20015W0.1	Compact Multi-point LED Flexible Strip 1000mm - Warm White	56
SE791050	RGB Receiver	62
SE791090	RGB Remote Control	62

Aluminium Profiles

Product Code	Product Description	Page Number
SE980120	Linia Recessed Aluminium Profile - 1000mm	64
SE981120	Fino Surface Mounted Profile - 1000mm	65

Sensio Midway Hanging Rail

Product Code	Product Description	Page Number
SE180221	Sensio Midway 1m Silver Profile	68
SE180520	Silver Small Shelf	68
SE180530	Black Small Shelf	69
SE180620	Silver Large Shelf	68
SE180630	Black Large Shelf	69
SE180720	Silver Utensil Hooks	68
SE180730	Black Utensil Hooks	69
SE180821	Sensio Midway 1m Black Profile	69
SE180920	Silver Kitchen Roll Holder	68
SE180930	Black Kitchen Roll Holder	69

Ceiling Lighting

Product Code	Product Description	Page Number
SE30034W0.1	White IP65 GU10 Fire Rated Ceiling Spot Light	71
SE30042W0.1	Chrome IP65 GU10 Fire Rated Ceiling Spot Light	71
SE32001W0	Bellatrix Crushed Crystal Pendant Light	73
SE32101W0	Zirconia Crystal Cone Pendant Light	72
SE37105C0.1	GU10 Dimmable COB LED Lamp - Cool White	71
SE37105W0.1	GU10 Dimmable COB LED Lamp - Warm White	71

Wireless Charging

Product Code	Product Description	Page Number
SE870980	Black Qi Wireless Charger	75
SE870990	White Qi Wireless Charger	75
SE871980	Qi Wireless Charging Receiver Phone Case - iPhone 5s	75
SE872980	Qi Wireless Charging Receiver Phone Case - iPhone 6	75

Product Index

SensioPod

Product Code	Product Description	Page Number
SE80050AL	Aluminium SensioPod Pull Up Socket	77
SE80050CH	Chrome SensioPod+ Pull Up Socket	78
SE80050GM	Black Nickel SensioPod+ Pull Up Socket	78
SE80050SS	Stainless Steel SensioPod+ Pull Up Socket	78
SE890900	SensioPower R Recessed Power Socket & USB	79
SE890920	SensioPod Bluetooth Pull Up Socket	80
SE891920	SensioPower U Bluetooth Power System with Shelf	81

Rechargeable Battery Wardrobe Lighting

Product Code	Product Description	Page Number
SE20051C0	Mimas LED Wardrobe Light	91
SE20061C0	Solus Angled LED Wardrobe Spot Light	90
SE20182C1	Alto LED Wardrobe Rail Light	88
SE20230W0.1	Prisma Tilttable LED Wardrobe Light	92
SE20242C0	Incline LED Wardrobe Strip Light	89
SE20292W0	Orion LED Under Bed Light	93

Low Voltage Wardrobe Lighting

Product Code	Product Description	Page Number
SE20021C0	Elara LED Wardrobe Rail Light	95
SE20081C0	Operio Mini LED Wardrobe Light	96
SE20111C0	Operio LED Wardrobe Light	97

LED Reading Lights

Product Code	Product Description	Page Number
SE20121C0	Opus LED Reading Light	99
SE20131C0	Flecto LED Reading Light	100

Lighting Control

Product Code	Product Description	Page Number
SE40515	In-Cabinet PIR Sensor Switch	108
SE40516.1	Cannon Cabinet/Swipe Sensor Switch	105
SE40518	250W In-Cabinet IR Sensor Switch	109
SE40520	Moda LED Dimming Sensor Switch	106
SE790050.1	LED Dimming Receiver	104
SE792990	Sensio Multi-Light App Bluetooth Receiver - Single Colour LED	103
SE793090	LED Dimming Remote Control	104
SE793990	Sensio Multi-Light App Bluetooth Receiver - RGB LED	103
SE794990	Sensio Multi-Light App Bluetooth Receiver - Duo Colour LED	103

Drivers

Product Code	Product Description	Page Number
SE40525	15W Driver with 6 Port JB4 Distributor	112
SE40526	30W Driver with 12 Port JB4 Distributor	112
SE40553	6W Driver with 4 Port JB4 Distributor	112
SE40555	15W Driver with 6 Port JB4 Distributor	112
SE40556	30W Driver with 12 Port JB4 Distributor	112
SE40557.1	60W Driver with 12 Port JB4 Distributor	112
SE40625	6W Driver with 4 port JB4 Distributor	112



Unit 7 Speedwell Road
Whitwood, Castleford
West Yorkshire
WF10 5PY

tel: +44 (0)845 0340 780
fax: +44 (0)845 0340 781
email: info@sensio.co.uk
web: www.sensio.co.uk

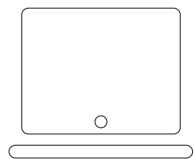

Desktop • Tablet • Mobile

www.sensio.co.uk

All prices are inclusive of 20% VAT and are Sensio's recommended retail prices. Prices are correct at the time of print (January 2017) and are subject to change after this date, without prior notification. All technical information is correct at the time of print however is subject to change throughout the course of the year.

